



INSTRUMENTS D'ÉCRITURE





La célèbre forme du capuchon BIC® en finition claire et opaque. Excellent rapport qualité/prix.





STYLOS
BIC® INSTRUMENTS D'ÉCRITURE





BIC® style
OPAQUE - 1610

TRANSPARENT - 1610

BIC® INSTRUMENTS D'ÉCRITURE

STYLOS



01/01 01/03 01/05 01/04

Encre de couleur



02/02



01/02



92 87 88 89 8H



93



Commande minimale 500v.

Personnalisation :

Bic® Style

1610

A SP: max. 2 col.

Bic® Style Clear

1610

B SP: max. 1 col.

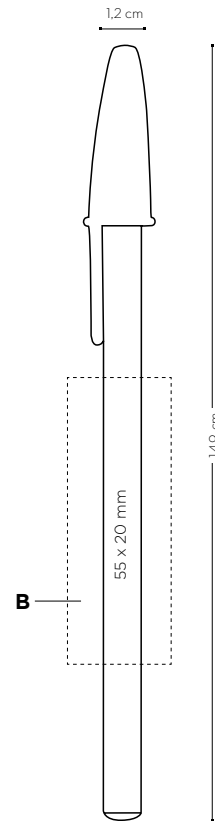
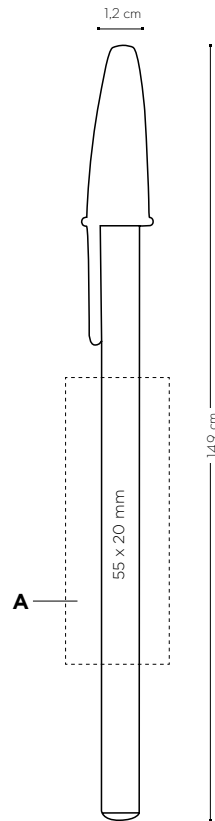

	Prix (€)					
Bic® Style / Bic® Style Clear	500-1111	1000-2411	2500-4111	5000-1111	10000-2411	25000-4111
1610						
SP	0,42	0,38	0,36	0,34	①	①

FRAIS D'IMPRESSION SUPPLÉMENTAIRES PAR COULEUR ET POSITION

SP	0,13	0,13	0,13	0,12	①	①
-----------	------	------	------	------	---	---

Les prix incluent la sérigraphie 1 couleur sur un emplacement.

① Prix sur demande.

Mode d'écriture :

Techniques d'impression :

Emballage externe :

Bille



M



(SP) SÉRIGRAPHIE



500 ± 3,5 Kg



L'icône BIC® Round Stic® offre un style indémodable et une très grande qualité. Son design classique est facile à identifier et est synonyme de fiabilité à long terme.



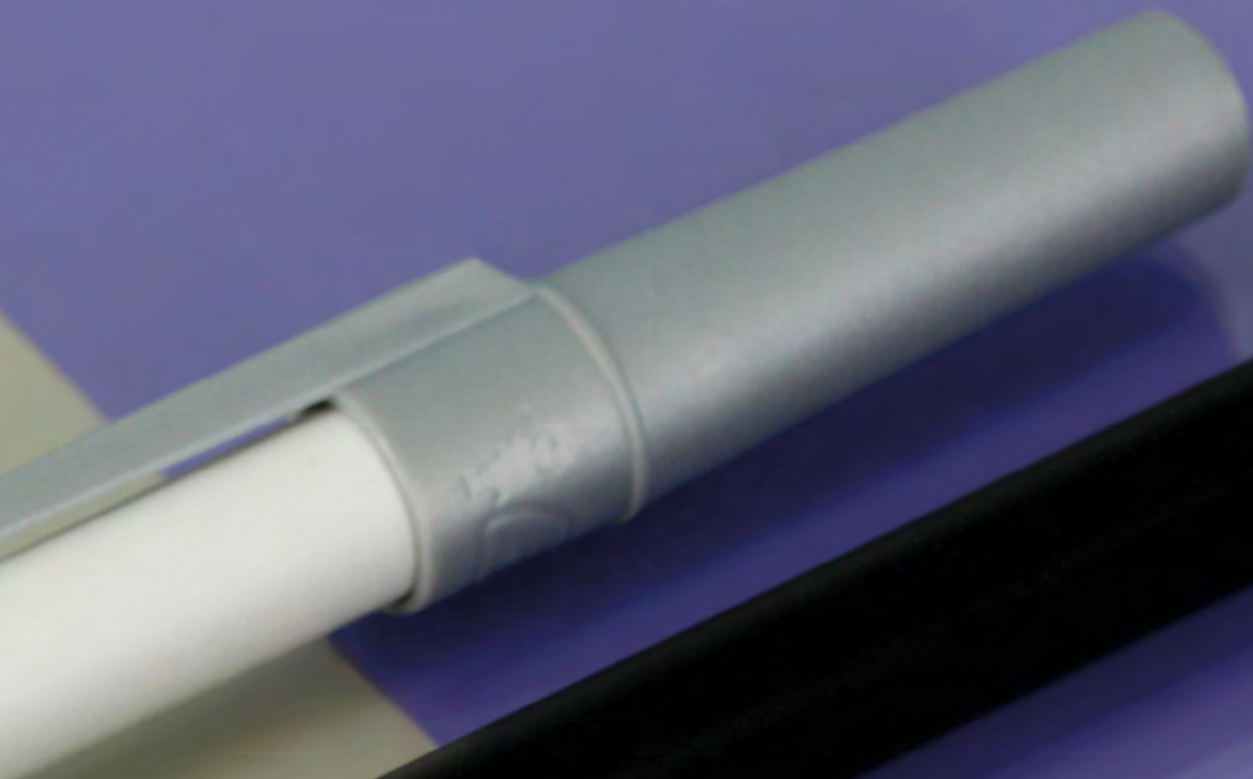



OPAQUE - 1010

GIVRÉ - 1010

l'icône BIC® BOY est en relief

BIC® INSTRUMENTS D'ÉCRITURE

STYLOS



01

12

03

05

07

18

02

69

63

71

66

68

67

40

Encre de couleur



Encre rouge disponible sur demande



* 48h non disponible en impression numérique

ecolutions® 69%
OPAQUE - 1E10



1E/8E

1E/7E

1E/10E



ecolutions® 69%
GIVRÉ - 1E10



1E/3E

2E/8E

2E/7E

2E/10E



Impression numérique!

BIC® Round stic® Digital
ecolutions®
OPAQUE - 1010/1E10



1E/10E

Disponible en corps blanc

01



STYLOS
BIC® INSTRUMENTS D'ÉCRITURE



Commande minimale 500v.

Combinaison de couleurs standards

Combinaison de couleurs standards **eColutions®**

Bouton

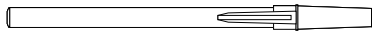

OPAQUE	01	12	10	03	05	20	04	07	18	02	GIVRÉ	69	63	71	66	68	67	40
--------	----	----	----	----	----	----	----	----	----	----	-------	----	----	----	----	----	----	----

Clip

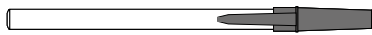

OPAQUE	01	12	10	03	05	20	04	07	18	02	GIVRÉ	69	63	71	66	68	67	40
--------	----	----	----	----	----	----	----	----	----	----	-------	----	----	----	----	----	----	----

Section

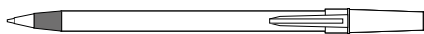

OPAQUE	01	12	10	03	05	20	04	07	18	02	GIVRÉ	69	63	71	66	68	67	40
--------	----	----	----	----	----	----	----	----	----	----	-------	----	----	----	----	----	----	----

Corps



OPAQUE	01	12	03	05	07	18	02	GIVRÉ	69	63	71	66	68	67	40
--------	----	----	----	----	----	----	----	-------	----	----	----	----	----	----	----

Injection d'une couleur spécifique :

≥ 10.000 unités

Combinaison de couleurs standards **eColutions®**

8E	7E	10E	3E
----	----	-----	----

8E	7E	10E	3E
----	----	-----	----

OPAQUE	GIVRÉ
1E	2E



eColutions® Fabriqué avec 69% de matériaux recyclés. Le pourcentage est calculé sur le poids total du produit.

Ajoutez l'anneau Möbius à votre article sans frais supplémentaire. N'oubliez pas de préciser < Imprimer l'anneau Möbius > dans votre commande. (L'anneau Möbius est imprimé par défaut dans le coin supérieur gauche)

Mode d'écriture :

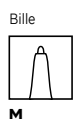

M

Techniques d'impression :



(SP) SÉRIGRAPHIE



(DG) NUMÉRIQUE

Emballage externe :



500 ± 2,5 Kg



FABRIQUÉ EN ESPAGNE

Personnalisation :

BIC® Round stic®

1010

@CColutions® 1E10

A SP: max. 3 col.

B SP: max. 1 col.

C DG: Numérique (Disponible en corps blanc)

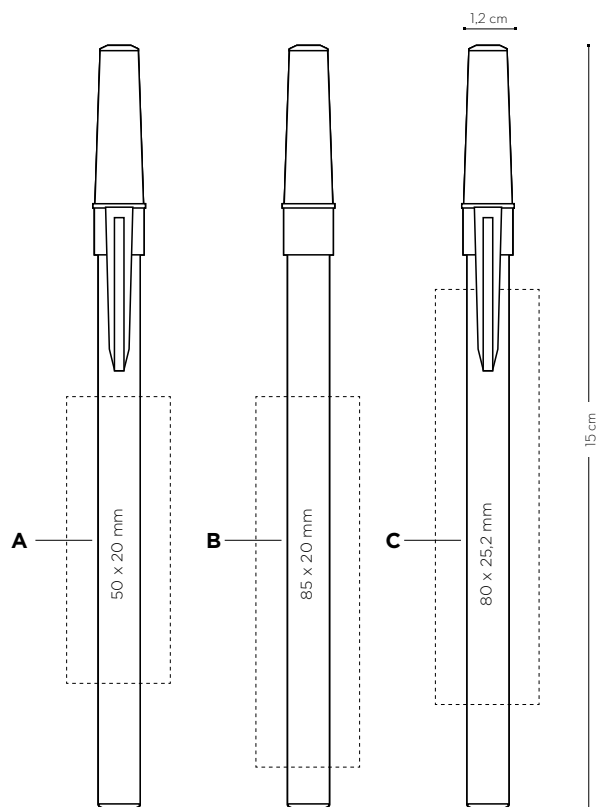

Prix (€)

BIC® Round stic®

1010

	500-111	1000-2411	2500-4111	5000-9111	10000-24111	25000-41111
SP	0,50	0,48	0,45	0,42	0,39	0,36
DG	0,69	0,66	0,62	0,58	①	①

@CColutions® 1E10

SP	0,56	0,53	0,49	0,46	①	①
DG	0,75	0,71	0,66	0,62	①	①

FRAIS D'IMPRESSION SUPPLÉMENTAIRES PAR COULEUR ET POSITION

SP	0,13	0,13	0,13	0,12	0,11	0,11
-----------	------	------	------	------	------	------

Les prix incluent une impression sur un emplacement avec la technique spécifiée.

① Prix sur demande.





Un classique revêtu de couleurs modernes - la qualité à un prix compétitif.







BIC[®] MIO[®] clic
1590



l'icône BIC[®] BOY est en relief

Bouton-poussoir latéral

BIC[®] INSTRUMENTS D'ÉCRITURE

STYLOS



Encre de couleur



Commande minimale 500v.

Personnalisation :

BIC® MIO® clic
1590
A SP: max. 2 col.

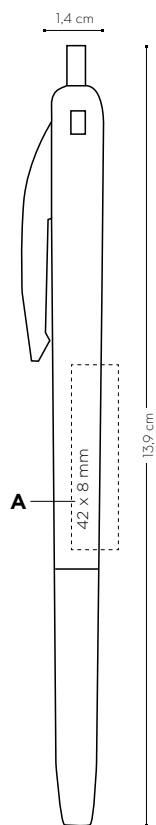

	Prix (€)					
BIC® MIO® clic 1590	500-499	1000-2499	2500-4999	5000-9999	10000-24999	25000-49999
SP	0,52	0,50	0,47	0,44	0,41	0,37
FRAIS D'IMPRESSION SUPPLÉMENTAIRES PAR COULEUR ET POSITION						
SP	0,13	0,13	0,13	0,12	0,11	0,11

Les prix incluent la sérigraphie 1 couleur sur un emplacement.

Mode d'écriture :



M

Techniques d'impression :



(SP) SÉRIGRAPHIE

Emballage externe :



1000 ± 8 Kg

Regardez la video



FABRIQUÉ
EN FRANCE



stylo blanc
FABRIQUÉ
EN SAF



Media Clic

Une véritable icône de l'écriture publicitaire par excellence, notre numéro un, l'original. De nombreuses possibilités d'impressions jusqu'à 4 couleurs sur le corps, et des milliers de combinaisons de coloris pour une personnalisation maximale!







POLI BILLE - 1025



l'icône BIC® BOY est en relief

BIC® INSTRUMENTS D'ÉCRITURE

STYLOS



Encre de couleur
Encre rouge disponible sur demande

* 48h non disponible en impression numérique



TRANSPARENT BILLE - 1025



Plus de 10 000 clics !

STYLOS
BIC® INSTRUMENTS D'ÉCRITURE





OPAQUE BILLE - 1025 / CRAYON 1028

BIC INSTRUMENTS D'ÉCRITURE

STYLOS

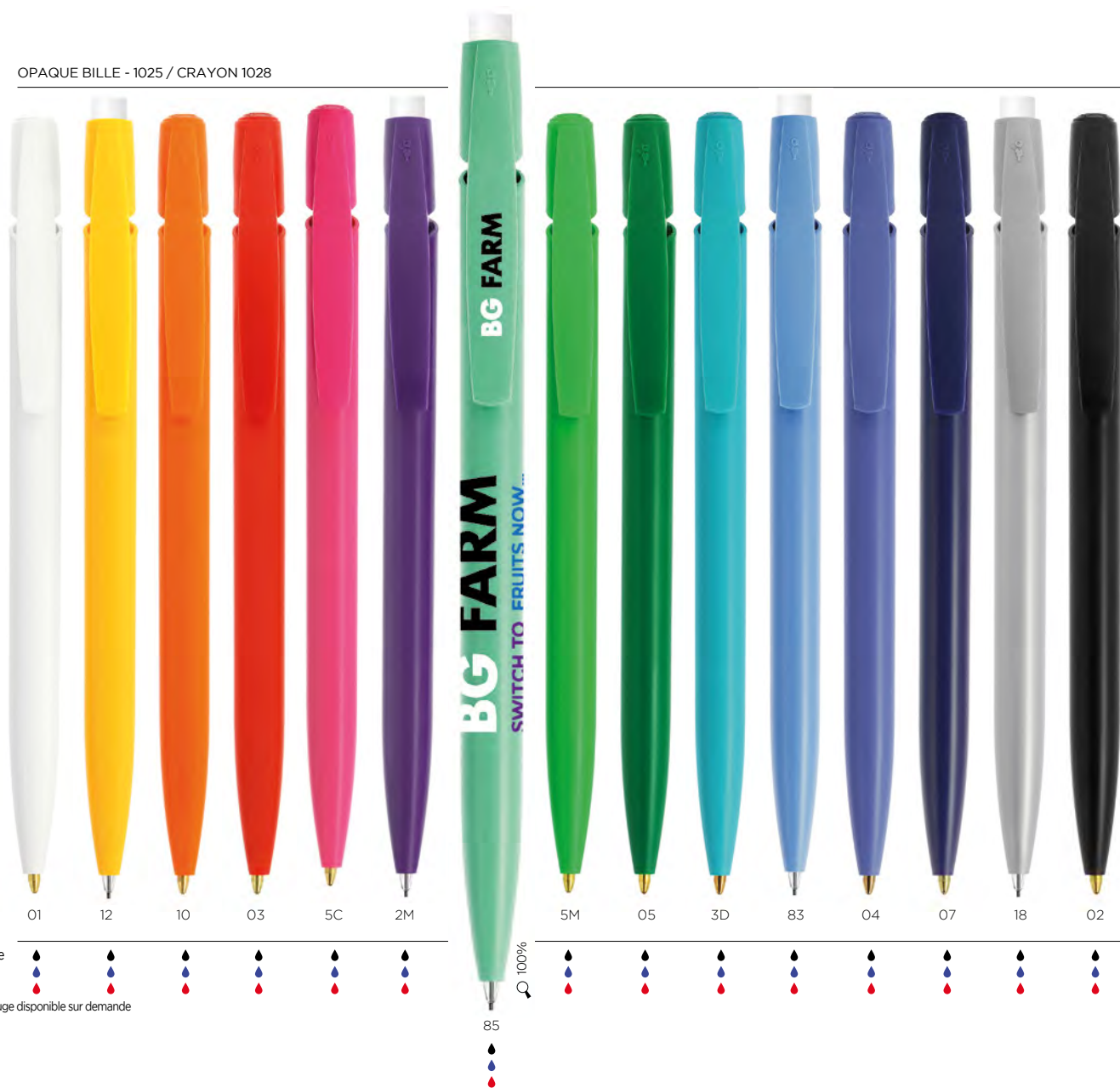

Encre de couleur
Encre rouge disponible sur demande

* 48h non disponible en impression numérique



GIVRÉ BILLE - 1025 / CRAYON 1028

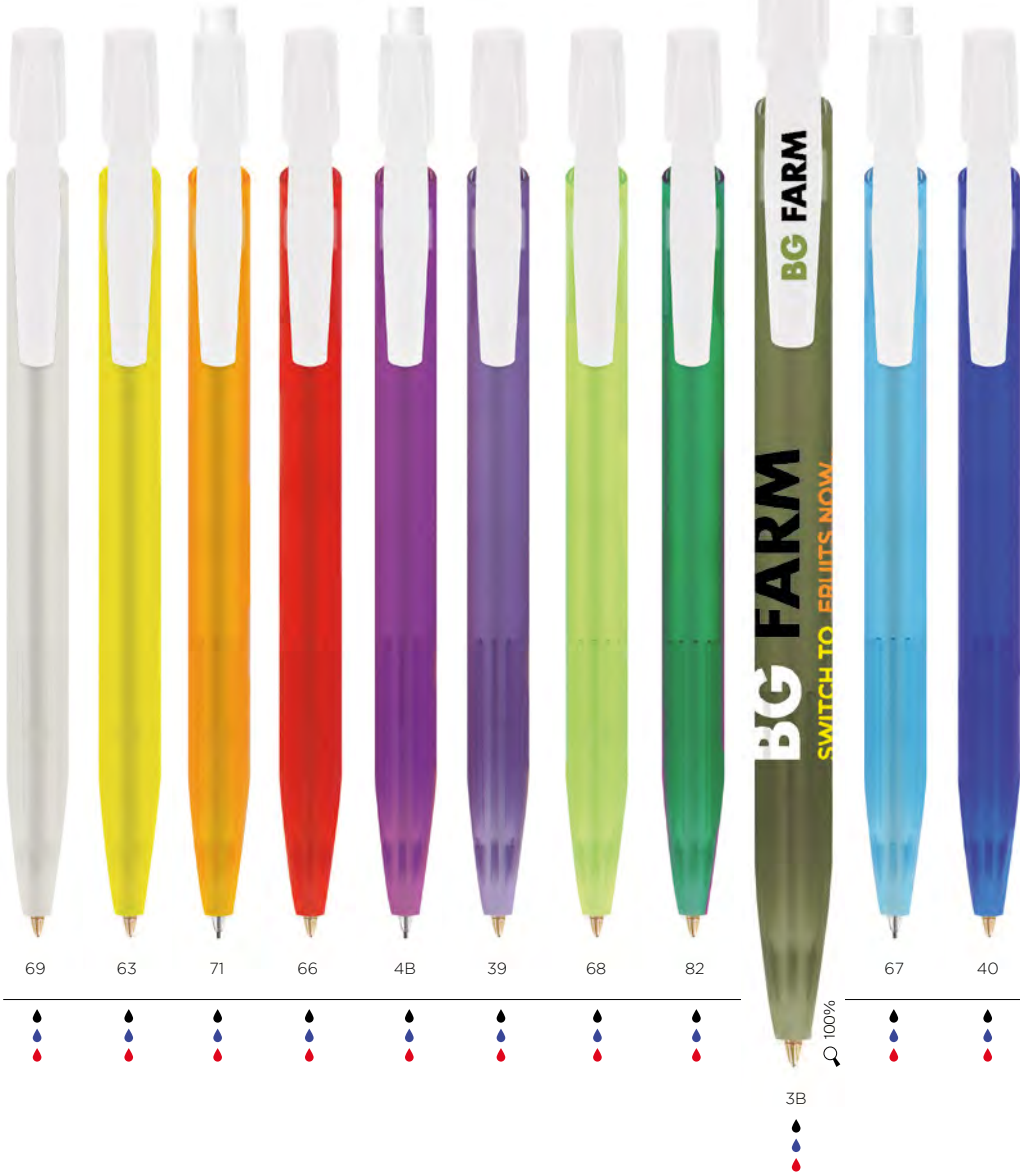

STYLOS
 BIC® INSTRUMENTS D'ÉCRITURE





Grip

MIX & MATCH



OPAQUE BILLE - 1020
CRAYON 1021

GIVRÉ BILLE - 1020 / CRAYON 1021

BIC INSTRUMENTS D'ÉCRITURE

STYLOS



01/12



01/03



01/05



01/07



01/02



01/69



69/69



71/69



66/69



82/69



40/69

Encre de couleur
Encre rouge disponible sur demande



* 48h non disponible en impression numérique

ecolutions®
 OPAQUE BILLE - 1E20
 CRAYON 1E21



01/12

01/03

01/05

01/02



01/07



Impression numérique!

BIC® Media Clic Digital
 OPAQUE BILLE - 1025
 CRAYON 1028

BIC® Media Clic Grip Digital
 OPAQUE BILLE - 1020 / 1E20
 CRAYON 1021 / 1E21



01

01/05

01/12

Uniquement disponible
 en corps blanc

Uniquement disponible
 en corps blanc



Regardez la video



STYLOS
 BIC® INSTRUMENTS D'ÉCRITURE



Commande minimale 500v.

Combinaison de couleurs standards

Bouton

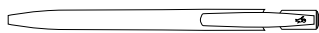

OPAQUE 01 12 10 03 5C 2D 13 84 85 5M 05 3D 83 04 07 29 2B 18 02 GIVRÉ 69

Clip

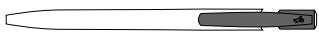

OPAQUE 01 12 10 03 5C 2D 13 84 85 5M 05 3D 83 04 07 29 2B 18 02 GIVRÉ 69

Corps



OPAQUE 01 8D 12 10 03 5C 2M 85 5M 05 3D 83 04 07 3C 18 02

CORPS ET GRIP 01/12 01/03 01/05 01/07 01/02

GIVRÉ 69 63 71 66 4B 39 68 82 67 40 3B

CORPS ET GRIP 01/69 69/69 71/69 66/69 82/69 40/69

POLI 1T 8T 6P 3T 6T 9T 5P 5T 4T 7T 8L 2T

TRANSPARENT 1R 4D 92 87 95 93 88 72 4R 7R 91

Injection d'une couleur spécifique :

≥ 10.000 unités 1025/1028

≥ 20.000 unités 1020/1021

Mode d'écriture :

Techniques d'impression :

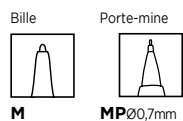

Commande minimale 500v.

Combinaison de couleurs standards @CColutions®

Bouton

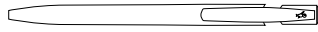

OPAQUE 01 12 10 03 5C 2D 13 84 85 5M 05 3D 83 04 07 29 2B 18 02 GIVRÉ 69

Clip

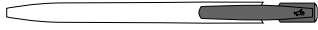

OPAQUE 01 12 10 03 5C 2D 13 84 85 5M 05 3D 83 04 07 29 2B 18 02 GIVRÉ 69

Corps

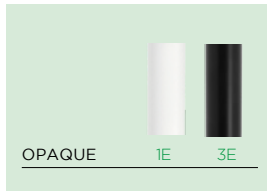

OPAQUE 1E 3E



@CColutions® Fabriqué avec 39% de matériaux recyclés.
Le pourcentage est calculé sur le poids total du produit.

Ajoutez l'anneau Möbius à votre article sans frais supplémentaire. N'oubliez pas de préciser < Imprimer l'anneau Möbius > dans votre commande. (L'anneau Möbius est imprimé par défaut dans le coin supérieur gauche)



BARREL & GRIP

01/12 01/03 01/05 01/07 01/02



@CColutions® Fabriqué avec 37% de matériaux recyclés.
Le pourcentage est calculé sur le poids total du produit.

Injection d'une couleur spécifique :

≥ 10.000 unités 1E25/1E28 1E20/1E21

≥ 20.000 unités 1E20 digital/1E21 digital

Mode d'écriture :

Techniques d'impression :

Bille



M

Porte-mine



MPØ0,7mm



(SP) SÉRIGRAPHIE



(DG) NUMÉRIQUE



(LE) LASER



Personnalisation :

BIC® Media Clic

- 1025 (bille)
- 1028 (crayon)
- ©©©olutions® 1E25 (bille)
- ©©©olutions® 1E28 (crayon)

- A SP:** max. 4 col.
- B SP:** max. 2 col.
- C DG:** Numérique

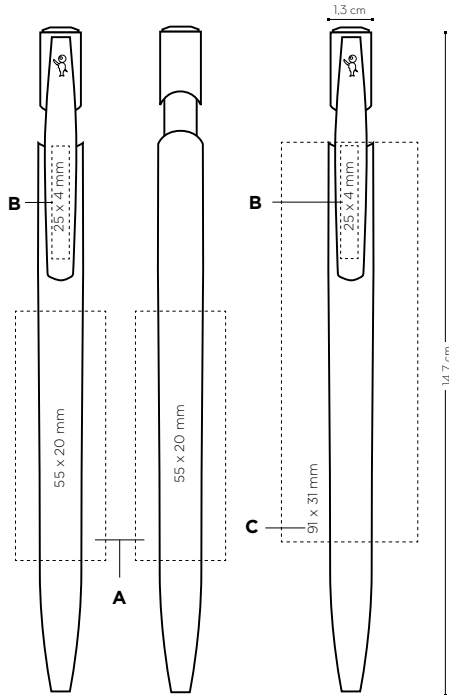

BIC® Media Clic Grip

- 1020 (bille)
- 1021 (crayon)
- ©©©olutions® 1E20 (bille)
- ©©©olutions® 1E21 (crayon)

- D SP:** max. 4 col.
- E SP:** max. 2 col.
- F DG:** Numérique

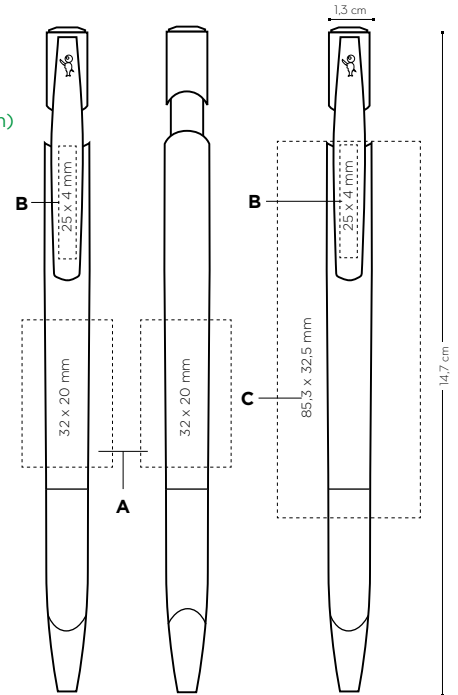

	Prix (€)					
BIC® Media Clic	500-4999	1000-24999	2500-49999	5000-99999	10000-249999	25000-499999
1025 (bille)						
SP	0,60	0,56	0,52	0,48	0,45	0,42
DG	0,82	0,77	0,71	0,67	①	①
1028 (crayon)						
SP	0,78	0,73	0,68	0,64	0,60	0,56
DG	0,92	0,86	0,80	0,76	①	①
©©©olutions® 1E25 (bille)						
SP	0,65	0,60	0,56	0,53	①	①
©©©olutions® 1E28 (crayon)						
SP	0,86	0,80	0,74	0,70	①	①
FRAIS D'IMPRESSION SUPPLÉMENTAIRES PAR COULEUR ET POSITION						
SP	0,13	0,13	0,13	0,12	0,11	0,11

Les prix incluent une impression sur un emplacement avec la technique spécifiée.

① Prix sur demande.

	Prix (€)					
BIC® Media Clic Grip	500-4999	1000-24999	2500-49999	5000-99999	10000-249999	25000-499999
1020 (bille)						
SP	0,90	0,84	0,79	0,73	0,68	0,63
DG	1,12	1,05	0,98	0,92	①	①
1021 (crayon)						
SP	1,00	0,93	0,87	0,82	0,76	0,71
DG	1,22	1,14	1,06	1,01	①	①
©©©olutions® 1E20 (bille)						
SP	1,00	0,93	0,87	0,82	①	①
DG	1,22	1,14	1,06	1,01	①	①
©©©olutions® 1E21 (crayon)						
SP	1,08	1,01	0,94	0,89	①	①
DG	1,30	1,22	1,13	1,08	①	①

FRAIS D'IMPRESSION SUPPLÉMENTAIRES PAR COULEUR ET POSITION

SP 0,13 0,13 0,13 0,12 0,11 0,11

Les prix incluent une impression sur un emplacement avec la technique spécifiée.

① Prix sur demande.

Emballage externe :



500 ± 4,1 Kg

Emballage externe :



500 ± 4,3 Kg

Regardez la video



FABRIQUÉ EN ESPAGNE



BIC® Media Clic Premium
OPAQUE BILLE - 1D25



Encre de couleur
Encre rouge disponible sur demande

BIC® Media Clic Premium

1D25
A SP: max. 4 col.
B SP: max. 1 col.
C LE

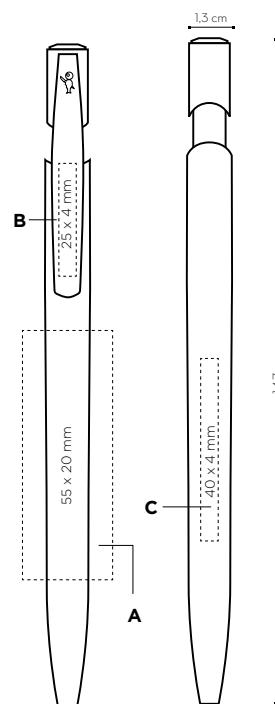

Commande minimale 500u.

Combinaison de couleurs standards

Bouton

PREMIUM 35

clip



PREMIUM 4A 5A*

Corps

PREMIUM

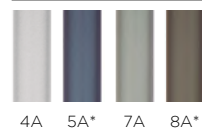

4A 5A* 7A 8A*

Prix (€)

BIC® Media Clic Premium 1D25	250-499	500-999	1000-2499	2500-4999	5000-9999	10000-24999	25000-49999
SP	1,49	1,35	1,25	1,16	1,09	1,01	0,95
LE	2,54	2,31	2,08	1,99	1,93	1,86	1,80

FRAIS D'IMPRESSION SUPPLÉMENTAIRES PAR COULEUR ET POSITION

SP	0,16	0,13	0,13	0,13	0,12	0,11	0,11
LE	1,21	1,09	0,96	0,96	0,96	0,96	0,96

Les prix incluent une impression sur un emplacement avec la technique spécifiée.

Mode d'écriture : Techniques d'impression : Emballage externe :

Bille



M



(SP) SÉRIGRAPHIE



(LE) LASER



500 ± 3,7 Kg



FABRIQUÉ EN ESPAGNE



*Jusqu'à épuisement du stock

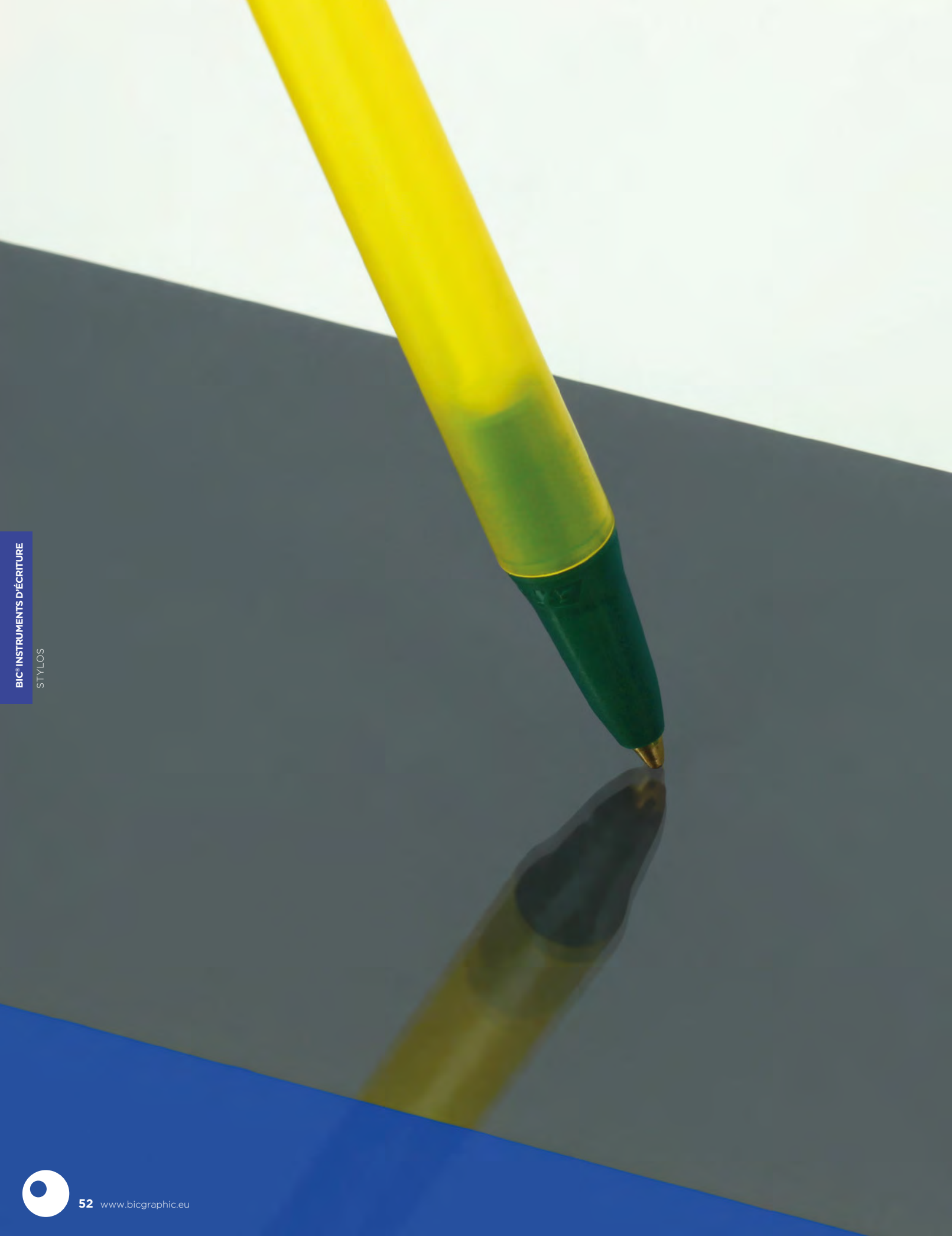

BIC® INSTRUMENTS D'ÉCRITURE

STYLOS





Moderne, fiable, flexible. C'est la définition même du BIC® Clic Stic! Une grande variété de finitions telles que Digital, Stylus, Softfeel® ou Mini, et plus de mille combinaisons de couleurs!



STYLOS
BIC® INSTRUMENTS D'ÉCRITURE





OPAQUE - 1000



Encre de couleur
Encre rouge disponible sur demande

l'icône BIC® BOY est en relief

ecolutions®
OPAQUE - 1E00



BIC® INSTRUMENTS D'ÉCRITURE

STYLOS



GIVRÉ - 1000

clip résistant
incassable !



ecolutions®
GIVRÉ - 1E00



BIC® clic stic Mini
OPAQUE - 1892



STYLOS
BIC® INSTRUMENTS D'ÉCRITURE





BIC® clic stic softfeet®
OPAQUE - 1005

GIVRÉ - 1005



Encre de couleur

Encre rouge disponible sur demande

02



100%

BIC® clic stic stylus
OPAQUE - 1847



100%



*48h non disponible en impression numérique

Impression numérique!

BIC® clic stic
Digital
OPAQUE - 1000



BIC® clic stic
Mini Digital
OPAQUE - 1892



BIC® clic stic
Stylus Digital
OPAQUE - 1847



01
●
●
●

01
●
●
●

01
●
●
●

Uniquement disponible en corps blanc



Commande minimale 500v.

Combinaison de couleurs standards

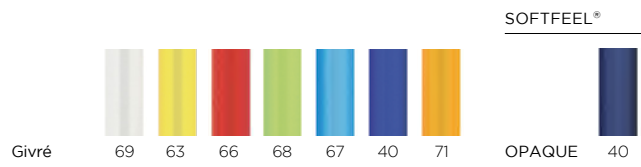
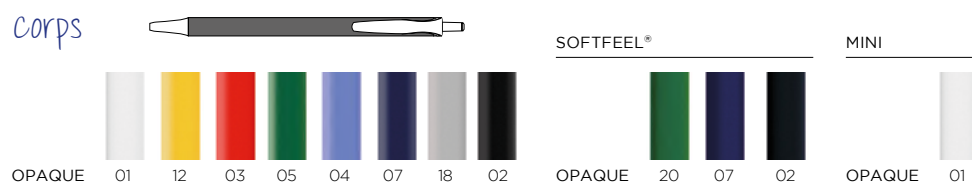
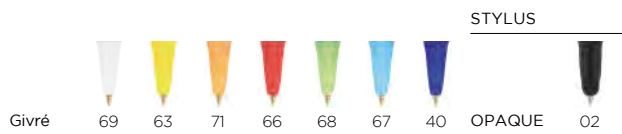
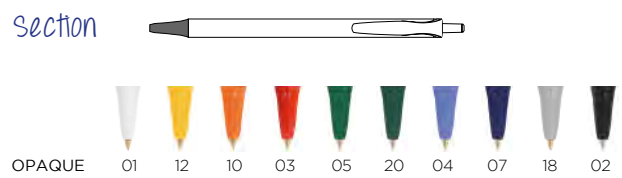

Injection d'une couleur spécifique :

≥ 10.000 unités

Mode d'écriture : Techniques d'impression :

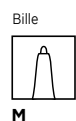

Commande minimale 500v.

Combinaison de couleurs standards **ecolutions®**

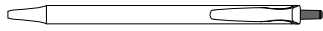
Bouton 

OPAQUE	01	12	10	03	05	20	04	07	18	02
--------	----	----	----	----	----	----	----	----	----	----

GIVRÉ	69	63	71	66	68	67	40
-------	----	----	----	----	----	----	----

clip 

OPAQUE	8E	7E	10E	3E
--------	----	----	-----	----

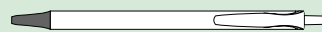
Section 

OPAQUE	8E	7E	10E	3E
--------	----	----	-----	----

Corps 

OPAQUE	1E	Givré	2E
--------	----	-------	----



ecolutions® Fabriqué avec 58% de matériaux recyclés.
Le pourcentage est calculé sur le poids total du produit.

Ajoutez l'anneau Möbius à votre article sans frais supplémentaire. N'oubliez pas de préciser < Imprimer l'anneau Möbius > dans votre commande.
(L'anneau Möbius est imprimé par défaut dans le coin supérieur gauche)

Injection d'une couleur spécifique :

≥ 10.000 unités

Mode d'écriture : Techniques d'impression :

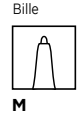

Personnalisation :

BIC® clic Stic
1000
eCOlutions® 1E00

BIC® clic Stic Stylus
1847

- A SP:** max. 3 col.
- B SP:** max. 1 col.
- C SP:** max. 2 col.
- D DG:** Numérique (zone texte)
(Disponible en corps blanc)
- E DG:** Numérique (zone image)
(Disponible en corps blanc)

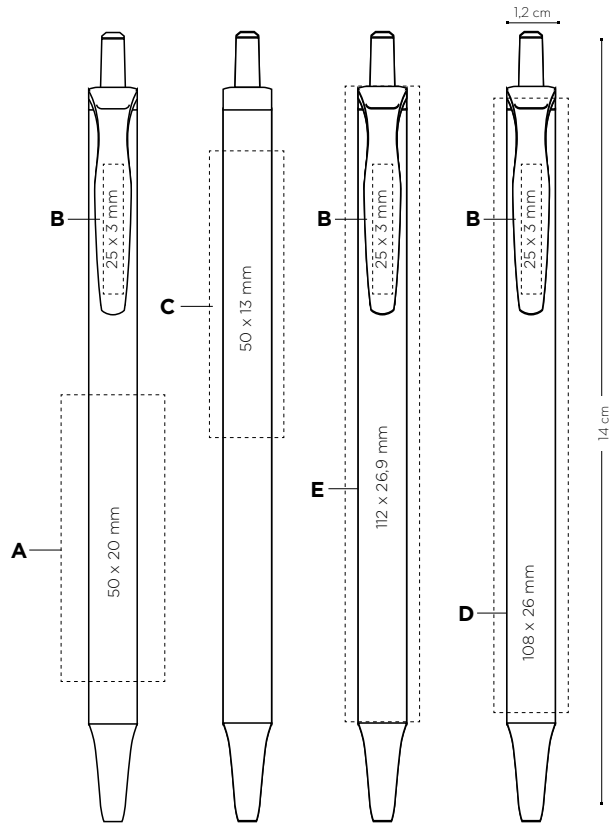

BIC® INSTRUMENTS D'ÉCRITURE
STYLOS

	Prix (€)					
BIC® clic Stic	500-1111	1000-2411	2500-4111	5000-1111	10000-2411	25000-4111
1000						
SP	0,74	0,69	0,65	0,61	0,57	0,53
DG	0,98	0,91	0,85	0,80	①	①
eCOlutions® 1E00						
SP	0,82	0,75	0,70	0,66	①	①
DG	1,06	0,97	0,90	0,85	①	①
1847						
SP	0,88	0,82	0,77	0,72	①	①
DG	1,12	1,04	0,97	0,91	①	①

FRAIS D'IMPRESSION SUPPLÉMENTAIRES PAR COULEUR ET POSITION

SP	0,13	0,13	0,13	0,12	0,11	0,11
-----------	------	------	------	------	------	------

Les prix incluent une impression sur un emplacement avec la technique spécifiée.

① Prix sur demande.

Emballage externe :



FABRIQUÉ EN ESPAGNE

BIC® Clic Stic softfeel®
1005

A/B SP: max. 1 col.

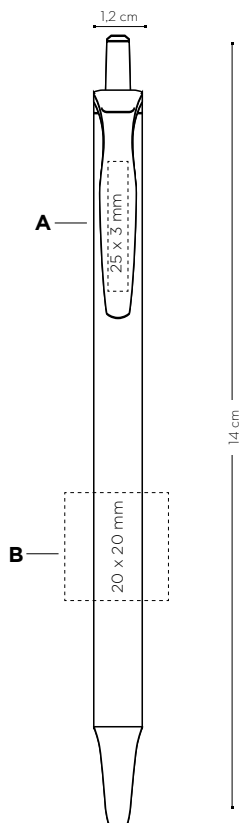

BIC® Clic Stic mini
1892

A SP: max. 1 col.

B SP: max. 1 col.

C DG: Numérique (zone texte)
(Disponible en corps blanc)

D DG: Numérique (zone image)
(Disponible en corps blanc)

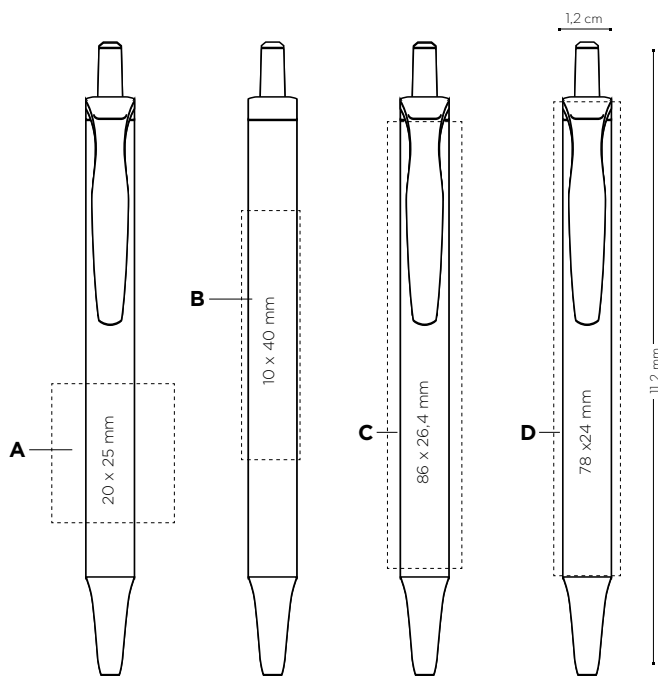

	Prix (€)					
BIC® Clic Stic softfeel® 1005	500-499	1000-2499	2500-4999	5000-9999	10000-24999	25000-49999
SP	0,86	0,80	0,75	0,70	0,65	0,60
FRAIS D'IMPRESSION SUPPLÉMENTAIRES PAR COULEUR ET POSITION						
SP	0,13	0,13	0,13	0,12	0,11	0,11

Les prix incluent la sérigraphie 1 couleur sur un emplacement.

	Prix (€)					
BIC® Clic Stic mini Digital 1892	500-499	1000-2499	2500-4999	5000-9999	10000-24999	25000-49999
SP	0,63	0,59	0,55	0,52	①	①
DG	0,90	0,84	0,78	0,74	①	①

Les prix incluent une impression sur un emplacement avec la technique spécifiée.
① Prix sur demande.

Emballage externe :



500 ± 2,9 Kg

Emballage externe :



500 ± 2,4 Kg

Super Clip

Design élégant et polyvalent, avec une grande variété de couleurs. De nombreuses possibilités de personnalisation avec sa zone d'impression XXL.





STYLOS
BIC® INSTRUMENTS D'ÉCRITURE





OPAQUE - 1039

BIC INSTRUMENTS D'ÉCRITURE

STYLOS



*48h non disponible en impression numérique





eco^{lutions}[®]
OPAQUE
1E50



01/1E

TRANSPARENT - 1039



51

92

87

95

93



88

100%

86

89

Impression
numérique!

BIC[®] Super Clip Digital
OPAQUE - 1039



01

Uniquement disponible
en corps blanc

01

100%



STYLOS
BIC[®] INSTRUMENTS D'ÉCRITURE



BIC® Super Clip

Commande minimale 250u.

Combinaison de couleurs standards

Combinaison de couleurs standards **eColutions®**

Clip

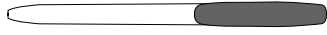

OPAQUE 01 8D 2F 1G 03 3H 1P 84 85 2G 83 04 07 06 27 02



CLEAR 51 92 87 95 93 88 86 89

Corps



OPAQUE 01 8D 2F 1G 03 3H 1P 84 85 2G 83 04 07 06 27 02



TRANSPARENT 51 92 87 95 93 88 86 89

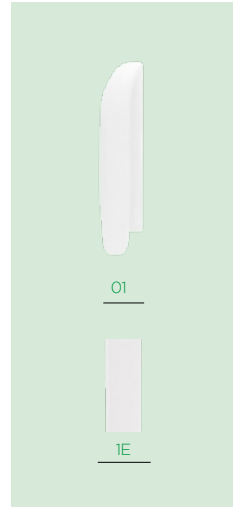

eColutions® Fabriqué avec 50% de matériaux recyclés.
Le pourcentage est calculé sur le poids total du produit.

Ajoutez l'anneau Möbius à votre article sans frais supplémentaire. N'oubliez pas de préciser < imprimer l'anneau Möbius > dans votre commande.
(L'anneau Möbius est imprimé par défaut dans le coin supérieur gauche)

Injection d'une couleur spécifique :

≥ 10.000 unités

Mode d'écriture :

Techniques d'impression :

Emballage externe :

Bille



M



(SP) SÉRIGRAPHIE



(DG) NUMÉRIQUE



(BP) britePix™



250 ± 2,6 Kg



FABRIQUÉ EN ESPAGNE



Personnalisation :

BIC® Super Clip

1039

©©olutions® 1E50

A SP: max. 2 col.

B SP: max. 1 col.

C DG: Numérique

D BP: Quadrichromie

BP Texture: Quadrichromie

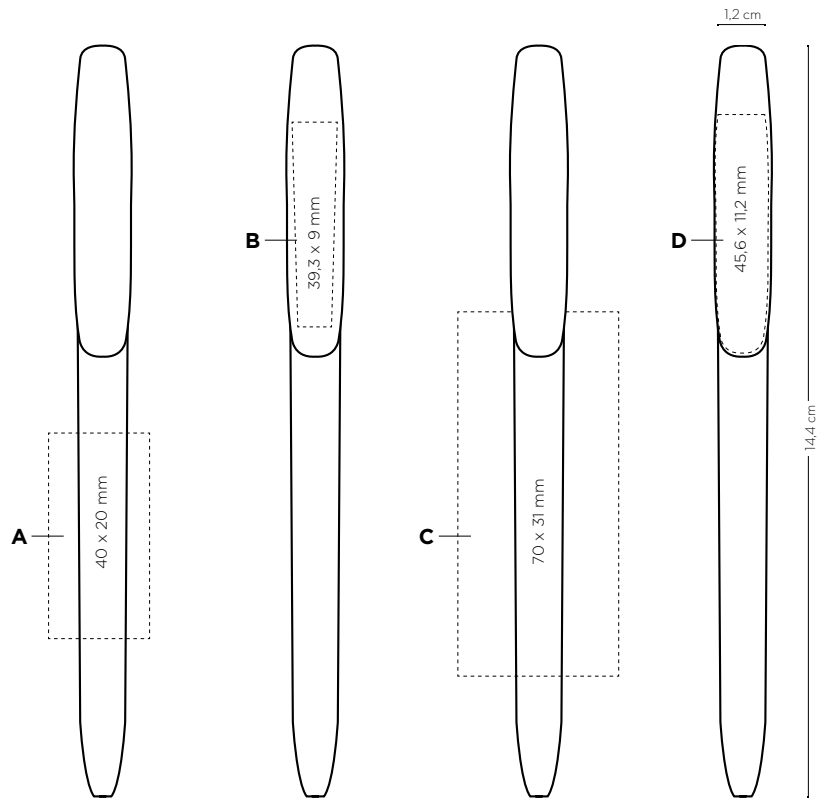

	Prix (€)						
BIC® Super Clip	250-444	500-444	1000-2444	2500-4444	5000-4444	10000-24444	25000-44444
1039							
SP	1,01	0,97	0,93	0,90	0,87	0,84	0,81
DG	1,31	1,26	1,21	1,17	1,13	①	①
BP	1,27	1,21	1,16	1,11	1,07	1,03	0,99
©©olutions® 1E50							
SP	1,11	1,06	1,02	0,99	0,95	①	①
DG	1,41	1,35	1,30	1,26	1,21	①	①
BP	1,39	1,32	1,27	1,22	1,17	①	①
FRAIS D'IMPRESSION SUPPLÉMENTAIRES PAR COULEUR ET POSITION							
SP	0,16	0,13	0,13	0,13	0,12	0,11	0,11
*BP Texture	0,17	0,15	0,14	0,14	0,13	0,12	0,12

Les prix incluent une impression sur un emplacement avec la technique spécifiée.

① Prix sur demande.

BIC Super Clip
Advance



MIX & MATCH



OPAQUE - 1073



*48h non disponible en impression numérique



BIC INSTRUMENTS D'ÉCRITURE
STYLOS



Impression numérique!

BIC® Super clip Advance Digital
OPAQUE - 1073



Uniquement disponible
en corps blanc

STYLOS
BIC® INSTRUMENTS D'ÉCRITURE



Super Clip Advance

Commande minimale 250u.

Combinaison de couleurs standards

Clip

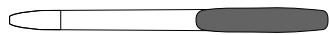

OPAQUE 01 2F 1G 03 3H 1P 2G 04 07 06 27 02



CLEAR 51 92 87 95 93 88 86 89

Corps



OPAQUE 01 2F 1G 03 3H 1P 2G 04 07 06 27 02



CLEAR 51 92 87 95 93 88 86 89

Section

ADVANCE



35

Injection d'une couleur spécifique :

≥ 10.000 unités

Mode d'écriture :

Bille



M

Techniques d'impression :



(SP) SÉRIGRAPHIE



(DG) NUMÉRIQUE



(BP) britePix™



Emballage externe :



500 ± 3,9 Kg

Regardez la video



FABRIQUÉ E
ESPAGNE



Personnalisation :

BIC® Super Clip Advance

1073

A SP: max. 2 col.

B SP: max. 1 col.

C DG: Numérique

D BP: Quadrichromie

BP Texture: Quadrichromie

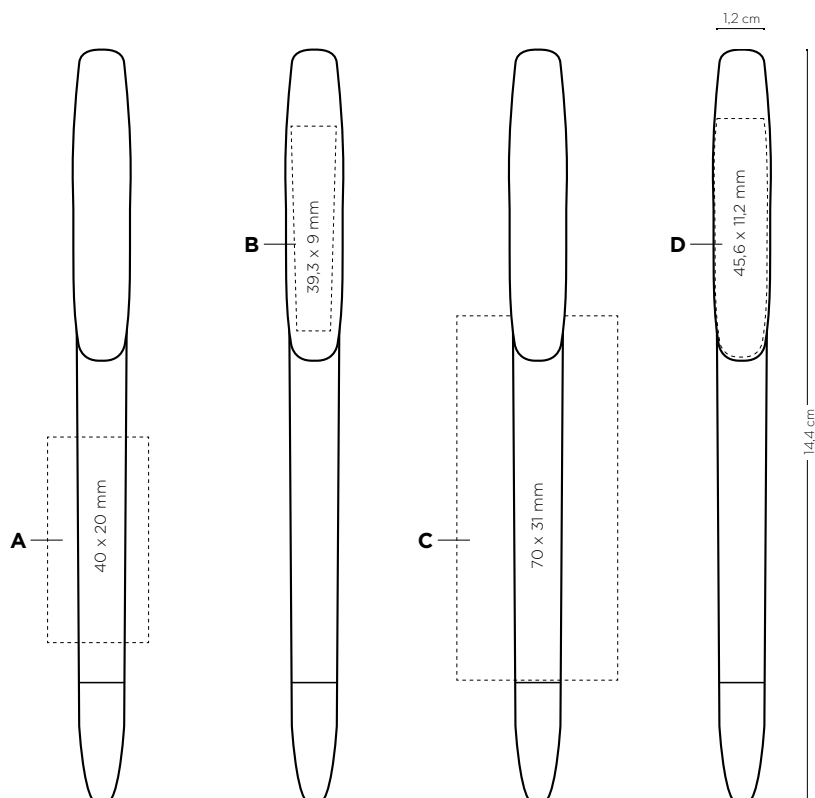

	Prix (€)						
BIC® Super Clip Advance	250-444	500-444	1000-2444	2500-4444	5000-4444	10000-24444	25000-44444
1073							
SP	1,42	1,35	1,29	1,25	1,21	1,17	1,12
DG	1,72	1,64	1,57	1,52	1,47	①	①
BP	1,64	1,55	1,48	1,43	1,38	1,33	1,27
FRAIS D'IMPRESSION SUPPLÉMENTAIRES PAR COULEUR ET POSITION							
SP	0,16	0,13	0,13	0,13	0,12	0,11	0,11
*BP Texture	0,17	0,15	0,14	0,14	0,13	0,12	0,12

Les prix incluent une impression sur un emplacement avec la technique spécifiée.

① Prix sur demande.





La taille idéale pour valoriser au mieux votre marque !
Corps large et multiples possibilités pour optimiser votre communication.





L'icône BIC® BOY est en relief

Notre plus grande zone d'impression !

OPAQUE - 1080

GIVRÉ - 1080



01 03 07

Encre de couleur
 ● ● ●
 ● ● ●
 ● ● ●

Encre rouge disponible sur demande



18

● ● ●
 ● ● ●

100%



02

● ● ●
 ● ● ●

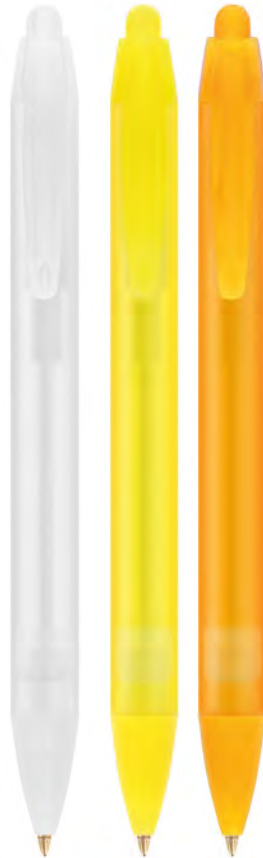

69 63 71

● ● ●
 ● ● ●
 ● ● ●



66

● ● ●
 ● ● ●

100%

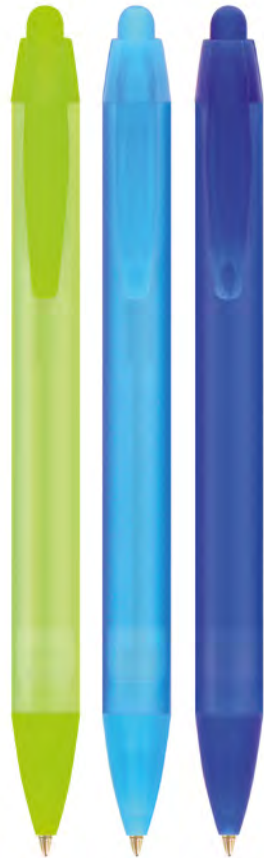

68 67 40

● ● ●
 ● ● ●
 ● ● ●



ecolutions®
OPAQUE - 1E80



1E

03

07

02

18



ecolutions®
GIVRÉ - 1E80



69

63

71

68

67

40

66



BIC Wide Body™
Chrome



MIX & MATCH



BIC® Wide Body™ Chrome
OPAQUE - 1079

GIVRÉ - 1079



BIC INSTRUMENTS D'ÉCRITURE

STYLOS

Encre de couleur

Encre rouge disponible sur demande

*48h non disponible en impression numérique



Impression numérique!

BIC® Wide Body™
Digital
OPAQUE - 1080



68



03



100%

BIC® Wide Body™
Mini Digital
OPAQUE - 1893



01



Uniquement
disponible en
corps blanc

01



100%

Impression numérique!

BIC® Wide Body™
Chrome Digital
OPAQUE - 1079



68



01



100%

BIC® Wide Body™
Chrome Mini Digital
OPAQUE - 1896



01



01



100%



BIC® Wide Body™

Commande minimale 250v.

Combinaison de couleurs standards

Bouton

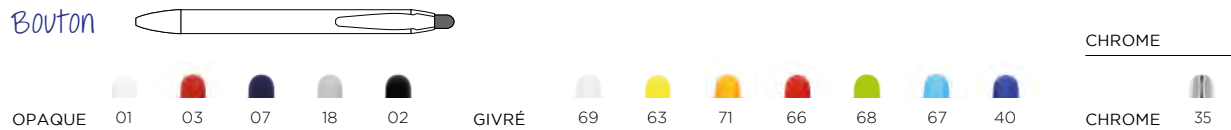

Clip



Corps



Section

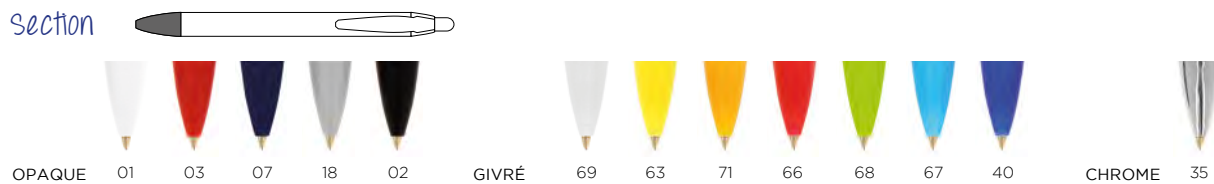

Injection d'une couleur spécifique :

≥ 10.000 unités

≥ 25.000 unités pour les sections personnalisées

Mode d'écriture : Techniques d'impression :

Bille



M



(SP) SÉRIGRAPHIE



(DG) NUMÉRIQUE

Commande minimale 250u.

Combinaison de couleurs standards **ecolutions®**

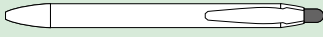
Bouton 

OPAQUE	01	03	07	18	02	GIVRÉ	69	63	71	66	68	67	40
--------	----	----	----	----	----	-------	----	----	----	----	----	----	----

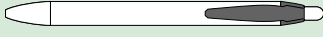
Clip 

OPAQUE	01	03	07	18	02	GIVRÉ	69	63	71	66	68	67	40
--------	----	----	----	----	----	-------	----	----	----	----	----	----	----

Corps 

OPAQUE	01	03	07	18	02	GIVRÉ	69	63	71	66	68	67	40
--------	----	----	----	----	----	-------	----	----	----	----	----	----	----

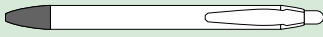
Section 

OPAQUE	01	03	07	18	02	GIVRÉ	69	63	71	66	68	67	40
--------	----	----	----	----	----	-------	----	----	----	----	----	----	----

Injection d'une couleur spécifique :

≥ 10.000 unités

≥ 25.000 unités pour les sections personnalisées



ecolutions® Fabriqué avec 33% de matériaux recyclés.
Le pourcentage est calculé sur le poids total du produit.

Ajoutez l'anneau Möbius à votre article sans frais supplémentaire. N'oubliez pas de préciser < Imprimer l'anneau Möbius > dans votre commande.

(L'anneau Möbius est imprimé par défaut dans le coin supérieur gauche)

Mode d'écriture : Techniques d'impression :

Bille



M



(SP) SÉRIGRAPHIE



(DG) NUMÉRIQUE



Personnalisation :

BIC® Wide Body™
1080
eSolutions® 1E80

BIC® Wide Body™ Chrome
1079

- A/C SP:** max. 2 col.
- B/F SP:** max. 1 col.
- D DG:** Numérique (zone image)
- E DG:** Numérique (zone texte)

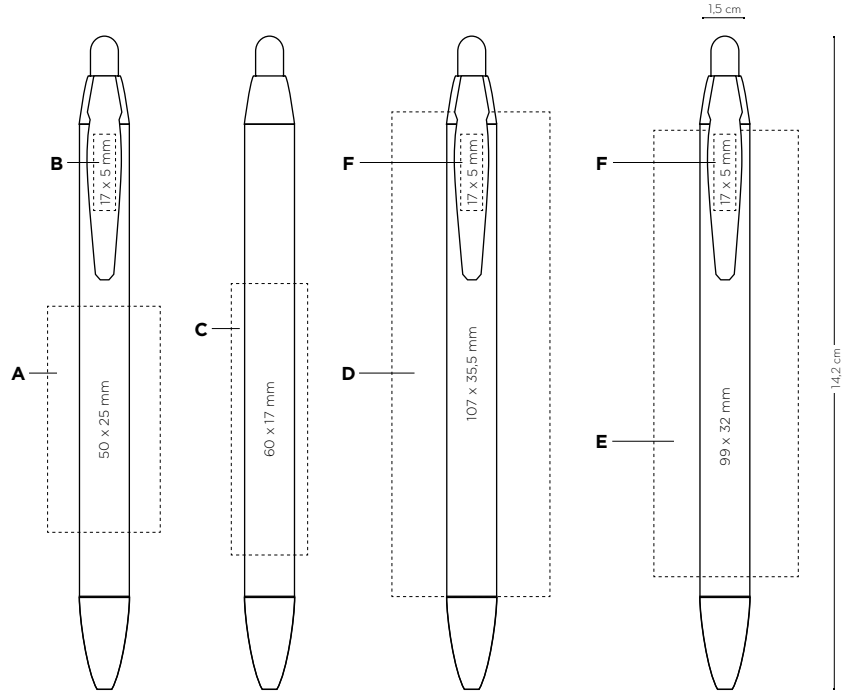

	Prix (€)						
BIC® Wide Body™	250-499	500-999	1000-2499	2500-4999	5000-9999	10000-24999	25000-99999
1080							
SP	1,04	0,95	0,89	0,83	0,76	①	①
DG	-	1,32	1,23	1,15	1,08	①	①
eSolutions® 1E80							
SP	1,16	1,04	0,98	0,91	0,86	①	①
DG	-	1,41	1,32	1,23	1,18	①	①
1079							
SP	1,98	1,80	1,68	1,59	1,45	①	①
DG	-	2,17	2,02	1,91	1,77	①	①

FRAIS D'IMPRESSION SUPPLÉMENTAIRES PAR COULEUR ET POSITION

SP	0,16	0,13	0,13	0,13	0,12	①	①
-----------	------	------	------	------	------	---	---

Les prix incluent une impression sur un emplacement avec la technique spécifiée.

① Prix sur demande.

Emballage externe :



250 ± 2,6 Kg



FABRIQUÉ EN ESPAGNE

BIC® Wide Body™ mini Digital
1893

BIC® Wide Body™ mini Chrome Digital
1896

A DG: Numérique (zone image)
B DG: Numérique (zone texte)

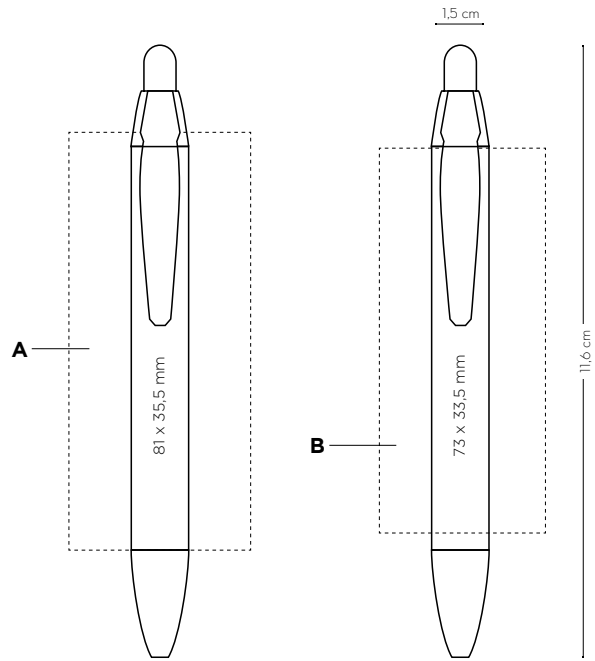

	Prix (€)					
BIC® Wide Body™ mini Digital	500-499	1000-2499	2500-4999	5000-9999	10000-24999	25000-49999
1893						
DG	1,17	1,09	1,02	0,96	①	①
1896						
DG	2,02	1,88	1,78	1,65	①	①

Les prix incluent l'impression numérique sur le corps.

① Prix sur demande.

Emballage externe :



250 ± 1,9 Kg



FABRIQUÉ EN
ESPAGNE





Design élégant et pratique avec grip en caoutchouc doux.
Une écriture fluide grâce au BIC® Easy Glide system®.







OPAQUE - 1053

TRANSPARENT - 1053



l'icône BIC® BOY est en relief

BIC® INSTRUMENTS D'ÉCRITURE

STYLOS



07 02 01/03 01/05 01/07

Encre de couleur



100%
01/02



51/07



51/02

Grip doux, très bonne prise en main

Commande minimale 250v.

Combinaison de couleurs standards

Personnalisation :

BIC® Atlantis®

1053

A PD: max. 1 col.

B/C SP: max. 2 col.

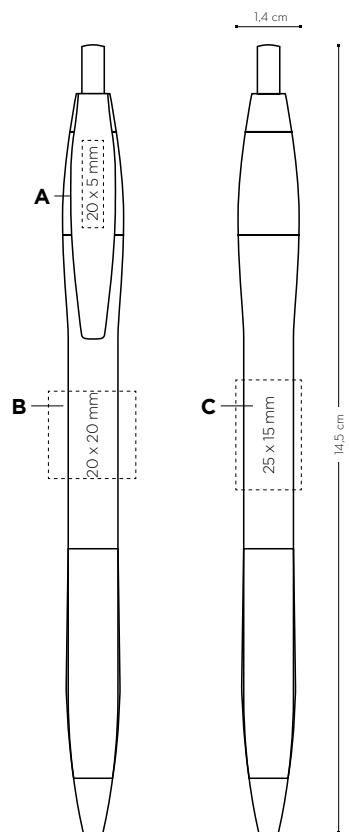

	Prix (€)						
BIC® Atlantis®	250-499	500-999	1000-2499	2500-4999	5000-9999	10000-24999	25000-49999
1053							
SP/PD	1,38	1,25	1,16	1,08	1,02	①	①

FRAIS D'IMPRESSION SUPPLÉMENTAIRES PAR COULEUR ET POSITION

SP/PD	0,16	0,13	0,13	0,13	0,12	①	①
--------------	------	------	------	------	------	---	---

Les prix incluent la sérigraphie 1 couleur sur un emplacement.

① Prix sur demande.

Mode d'écriture : Techniques d'impression : Emballage externe :

Bille



M



(SP) SÉRIGRAPHIE



(PD) TAMOGRAPHIE



250 ± 2,3 Kg



FABRIQUÉ EN FRANCE



Un design multifonction qui s'adapte à tous les styles, du classique au moderne, et qui donne à votre message une vraie dimension de responsabilité environnementale.

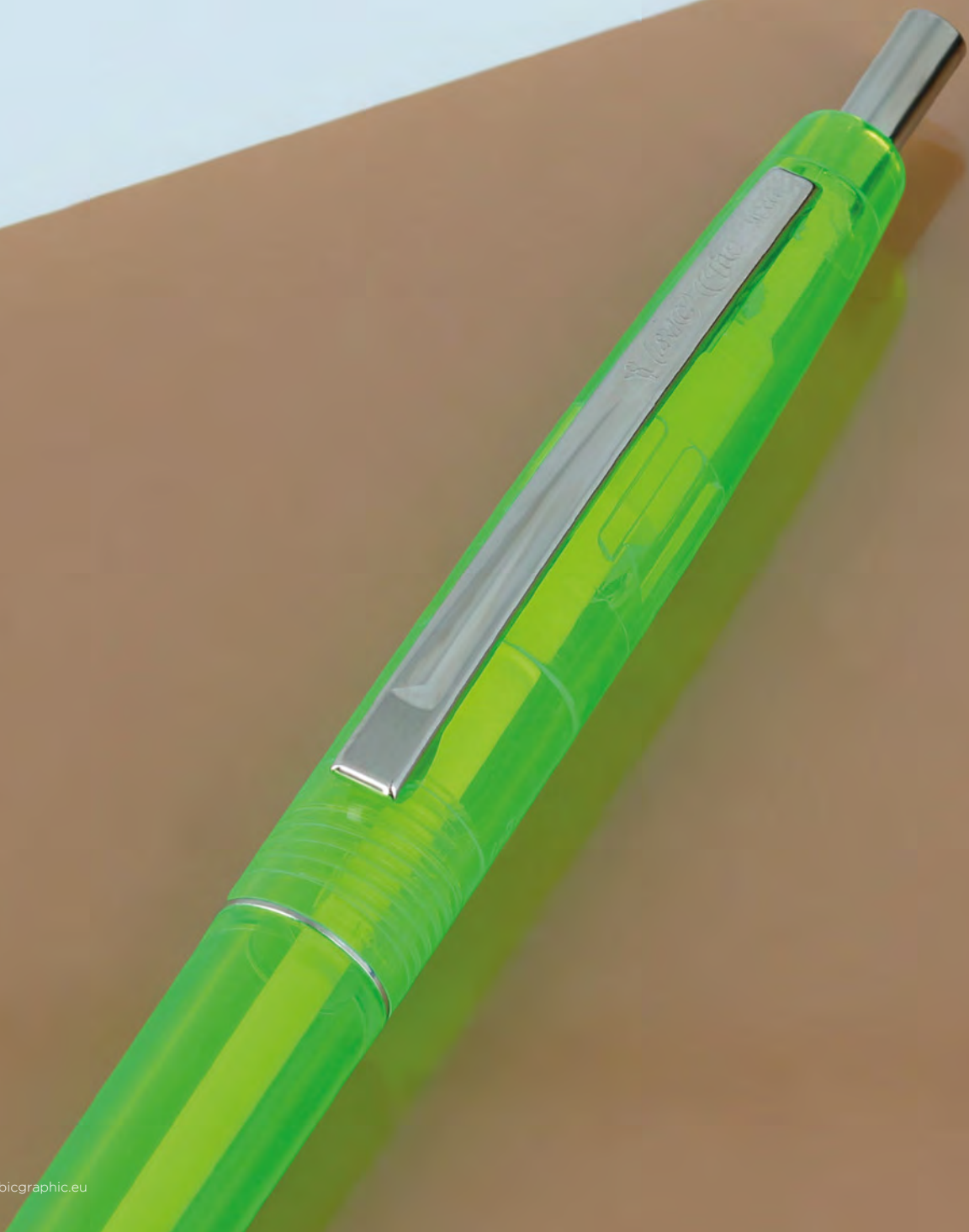





l'icône BIC® BOY est en relief



BIC® clic **ecolutions**[®]
OPAQUE - 1093

BIC® clic **ecolutions**[®]
TRANSPARENT - 1093



01/35 12/35 03/35

Encre de couleur



5C/35



59/35 04/35 07/35 02/35



95/35 93/35



88/35



Commande minimale 250v.

Personnalisation :

BIC® Clic eColutions®
 eColutions® 1093
 BIC® Clic Gold eColutions®
 eColutions® 1091

A SP: max. 2 col.

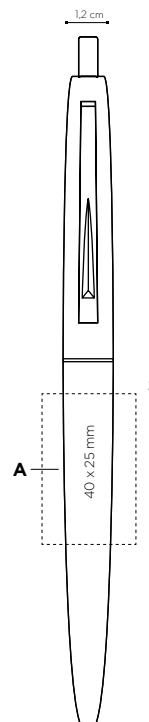

BIC® Clic Gold eColutions®
 OPAQUE - 1091

TRANSPARENT
 1091



Prix (€)

BIC® Clic eColutions®	250-499	500-999	1000-2499	2500-4999	5000-9999	10000-24999	25000-49999
BIC® Clic Gold eColutions®							
eColutions® 1093/1091							

SP	1,48	1,33	1,24	1,16	1,09	①	①
----	------	------	------	------	------	---	---

FRAIS D'IMPRESSION SUPPLÉMENTAIRES PAR COULEUR ET POSITION

SP	0,16	0,13	0,13	0,13	0,12	①	①
----	------	------	------	------	------	---	---

Les prix incluent la sérigraphie 1 couleur sur un emplacement.

① Prix sur demande.

Mode d'écriture : Techniques d'impression : Emballage externe :



M

Jusqu'à épuisement du stock



(SP) SÉRIGRAPHIE



250 ± 2,3 Kg

4 COLOURS

Simple, fiable, ingénieux. Quatre couleurs d'encre différentes sur un seul stylo à bille : bleu, noir, rouge, vert. Un stylo emblématique toujours plus à la mode !



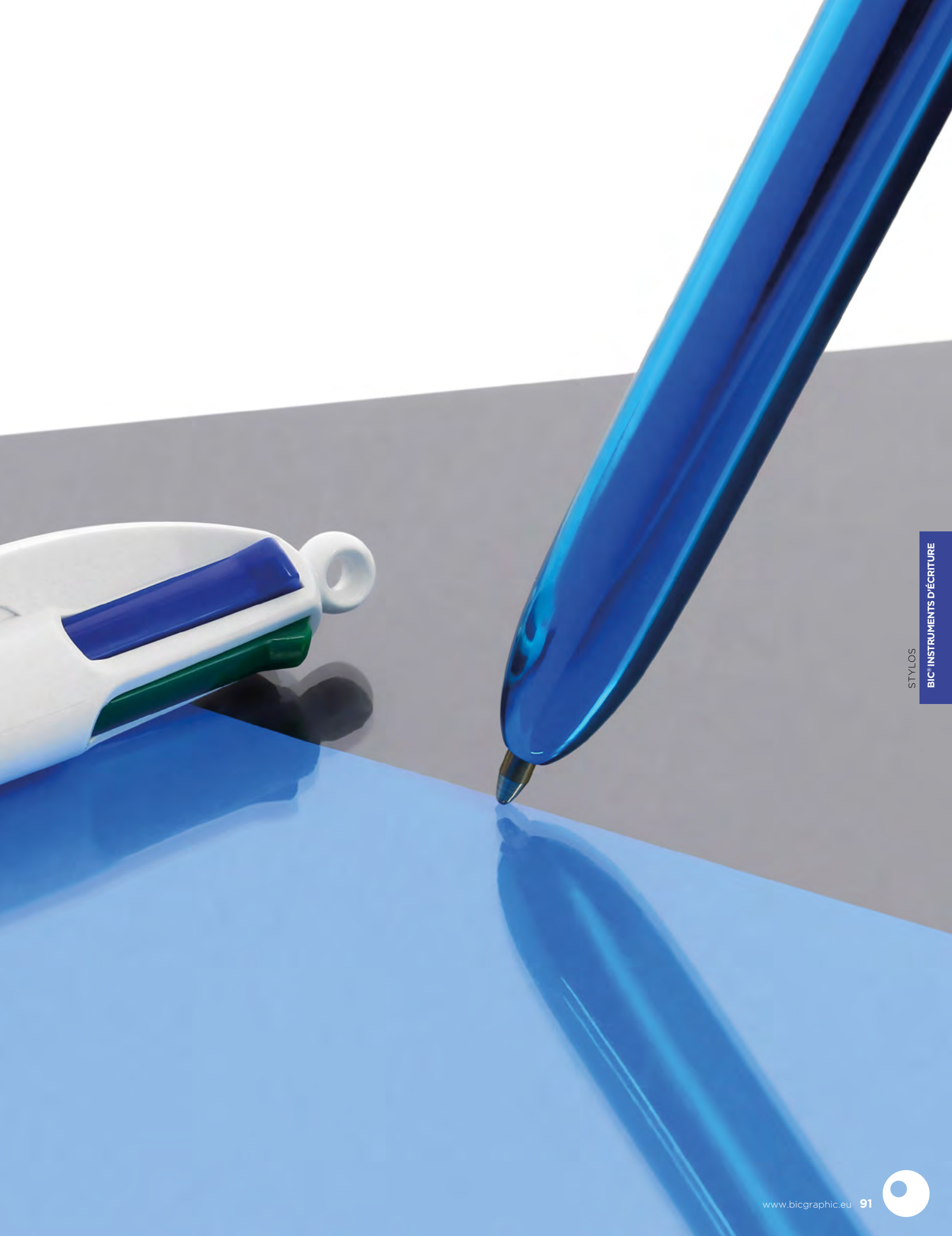

STYLOS
BIC® INSTRUMENTS D'ÉCRITURE



BIC® 4 Colours



BIC® 4 Colours
OPAQUE - 1100
avec tour de cou - 1101



BIC® INSTRUMENTS D'ÉCRITURE

STYLOS

Impression numérique!

BIC® 4 Colours Digital
OPAQUE - 1100
avec tour de cou - 1101



Uniquement disponible en corps blanc



*48h non disponible en impression numérique
Disponible sans tour de cou

** Source: GFK Panel - Western Europe 9 - MAT juin 2018 - Ventes en valeur et volume

Commande minimale 250v.

Personnalisation :

BIC® 4 Colours

1100

A SP: max. 4 col.

B DG: Numérique

(Disponible en corps blanc)

C BP: Quadrichromie

BP Texture: Quadrichromie

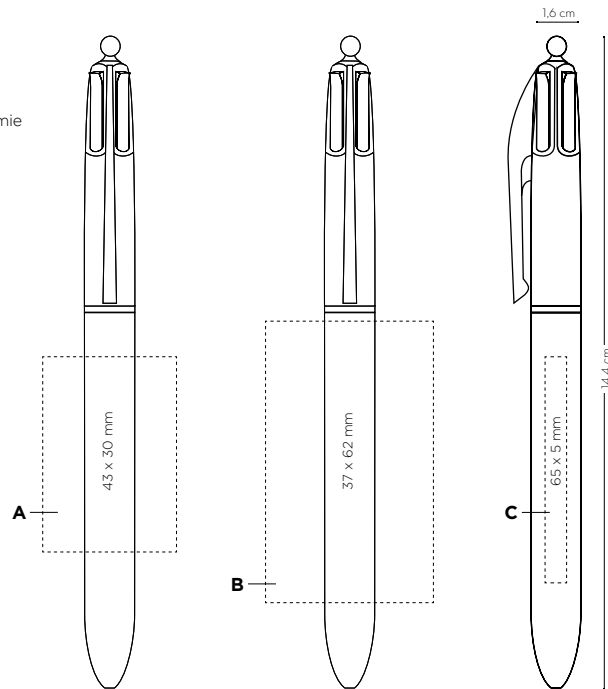

	Prix (€)							
BIC® 4 Colours	00-241	250-411	500-411	1000-2411	2500-4111	5000-4111	10000-24111	25000-41111
1100								
SP	-	2,88	2,61	2,42	2,26	2,13	1,98	1,83
DG	-	3,94	3,57	3,31	3,08	2,91	2,70	2,50
BP	3,82	3,11	2,82	2,62	2,45	2,31	2,14	1,98
1101 (tour de cou)								
SP	-	3,29	2,98	2,76	2,59	2,44	2,29	2,13
DG	-	4,35	3,94	3,65	3,41	3,22	3,01	2,80
BP	4,28	3,52	3,19	2,96	2,78	2,62	2,45	2,28
FRAIS D'IMPRESSION SUPPLÉMENTAIRES PAR COULEUR ET POSITION								
SP	-	0,16	0,13	0,13	0,13	0,12	0,11	0,11
BP	0,25	0,23	0,21	0,20	0,19	0,18	0,16	0,15
BP Texture	0,19	0,17	0,15	0,14	0,14	0,13	0,12	0,12

Les prix incluent une impression sur un emplacement avec la technique spécifiée.

Mode d'écriture :

Techniques d'impression :

Emballage externe :

Regardez la video

Bille



M



(SP) SÉRIGRAPHIE



(DG) NUMÉRIQUE



(BP) britePix™



250 ± 3,2 Kg



FABRIQUÉ
EN FRANCE





BIC® 4 Colours Mini
OPAQUE - 1103
avec tour de cou - 1104

BIC® INSTRUMENTS D'ÉCRITURE

STYLOS



l'icône BIC® BOY est en relief

Commande minimale 250v.

Personnalisation :

BIC® 4 Colours Mini
1103
D SP: max. 4 col.

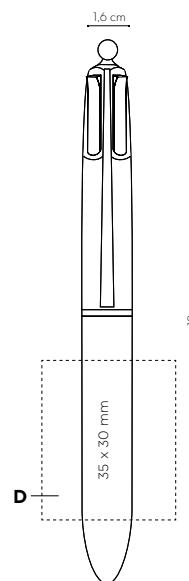

BIC® 4 Colours Mini	250-499	500-999	1000-2499	2500-4999	5000-9999	10000-24999	25000-49999	Prix (€)
1103								
SP	3,07	2,78	2,58	2,41	2,27	2,18	2,10	
1104 (tour de cou)								
SP	3,48	3,15	2,92	2,74	2,58	2,49	2,40	

FRAIS D'IMPRESSION SUPPLÉMENTAIRES PAR COULEUR ET POSITION

SP	0,16	0,13	0,13	0,13	0,12	0,11	0,11
----	------	------	------	------	------	------	------

Les prix incluent la sérigraphie 1 couleur sur un emplacement.

Mode d'écriture : Techniques d'impression : Emballage externe :

Bille



M



(SP) SÉRIGRAPHIE



250 ± 2,7 Kg



*48h non disponible en impression numérique
Disponible sans tour de cou



SUN



BIC® 4 Colours Sun
OPAQUE - 1097
avec tour de cou - 1098

2 nouvelles couleurs flashy : orange et jaune



Commande minimale 250u.

Personnalisation :

BIC® 4 Colours Sun
1097
A SP: max. 4 col.
(Disponible en corps blanc)
B BP: Quadrichromie
BP Texture: Quadrichromie

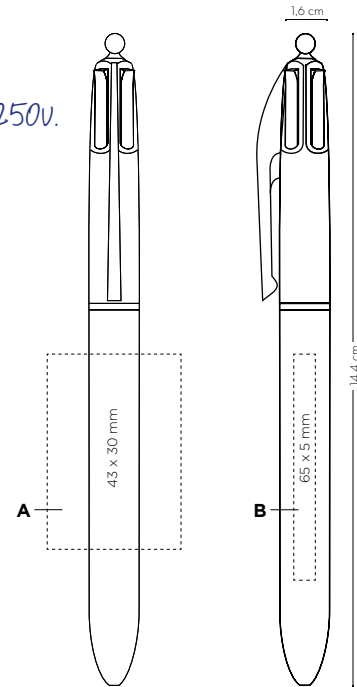

Prix (€)

BIC® 4 Colours Sun	100-249	250-499	500-999	1000-2499	2500-4999	5000-9999	10000-24999	25000-49999
1097	-	2,88	2,61	2,42	2,26	2,13	1,98	1,83
SP	-	2,88	2,61	2,42	2,26	2,13	1,98	1,83
BP	3,82	3,11	2,82	2,62	2,45	2,31	2,14	1,98
1098 (tour de cou)								
SP	-	3,29	2,98	2,76	2,59	2,44	2,29	2,13
BP	4,28	3,52	3,19	2,96	2,78	2,62	2,45	2,28

FRAIS D'IMPRESSION SUPPLÉMENTAIRES PAR COULEUR ET POSITION

SP	-	0,16	0,13	0,13	0,13	0,12	0,11	0,11
BP	0,25	0,23	0,21	0,20	0,19	0,18	0,16	0,15
BP Texture	0,19	0,17	0,15	0,14	0,14	0,13	0,12	0,12

Les prix incluent une impression sur un emplacement avec la technique spécifiée.

Mode d'écriture : Techniques d'impression : Emballage externe :

Bille



M



(SP) SÉRIGRAPHIE



(BP) britePix™



250 ± 3,2 Kg



FABRIQUÉ EN FRANCE



*48h non disponible en impression numérique
Disponible sans tour de cou





Encres fantaisie

BIC® 4 Colours Fashion
OPAQUE - 1102
avec tour de cou - 1108

BIC® 4 Colours Digital
OPAQUE - 1102
avec tour de cou - 1108

BIC® INSTRUMENTS D'ÉCRITURE

STYLOS



Impression numérique!

Uniquement disponible en corps blanc

*48h non disponible en impression numérique
Disponible sans tour de cou



Commande minimale 250v.

Personnalisation :

BIC® 4 Couleurs Fashion
1102

A SP: max. 4 col.

B DG: Numérique

(Disponible en corps blanc)

C BP: Quadrichromie

BP Texture: Quadrichromie

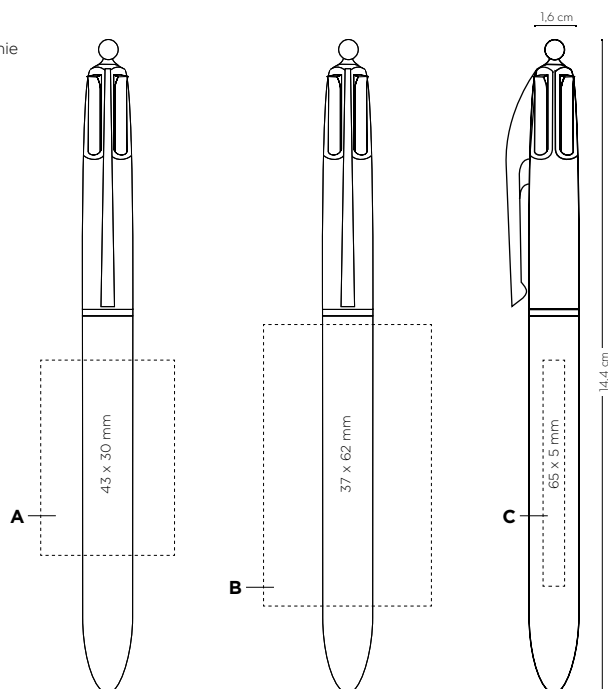

	Prix (€)							
BIC® 4 Couleurs Fashion	100-244	250-444	500-444	1000-2444	2500-4444	5000-4444	10000-24444	25000-44444
1102								
SP	-	2,88	2,61	2,42	2,26	2,13	1,98	1,83
DG	-	3,94	3,57	3,31	3,08	2,91	2,70	2,50
BP	3,82	3,11	2,82	2,62	2,45	2,31	2,14	1,98
1108 (tour de cou)								
SP	-	3,29	2,98	2,76	2,59	2,44	2,29	2,13
DG	-	4,35	3,94	3,65	3,41	3,22	3,01	2,80
BP	4,28	3,52	3,19	2,96	2,78	2,62	2,45	2,28
FRAIS D'IMPRESSION SUPPLÉMENTAIRES PAR COULEUR ET POSITION								
SP	-	0,16	0,13	0,13	0,13	0,12	0,11	0,11
BP	0,25	0,23	0,21	0,20	0,19	0,18	0,16	0,15
BP Texture	0,19	0,17	0,15	0,14	0,14	0,13	0,12	0,12

Les prix incluent une impression sur un emplacement avec la technique spécifiée.

Mode d'écriture : Techniques d'impression :

Emballage externe :

Bille



M



(SP) SÉRIGRAPHIE



(DG) NUMÉRIQUE



(BP) britePix™



250 ± 3,2 Kg



FABRIQUÉ
EN FRANCE

BIC® 4 Colours
Shine



BIC® 4 Colours Shine
OPAQUE - 1106
avec tour de cou - 1107



Corps super
brillant !

BIC® INSTRUMENTS D'ÉCRITURE
STYLOS



Commande minimale 250v.

Personnalisation :

BIC® 4 Couleurs Shine

1106

A SP: max. 4 col.

B LE

C LE

Nouveau ! **D LE 360°**

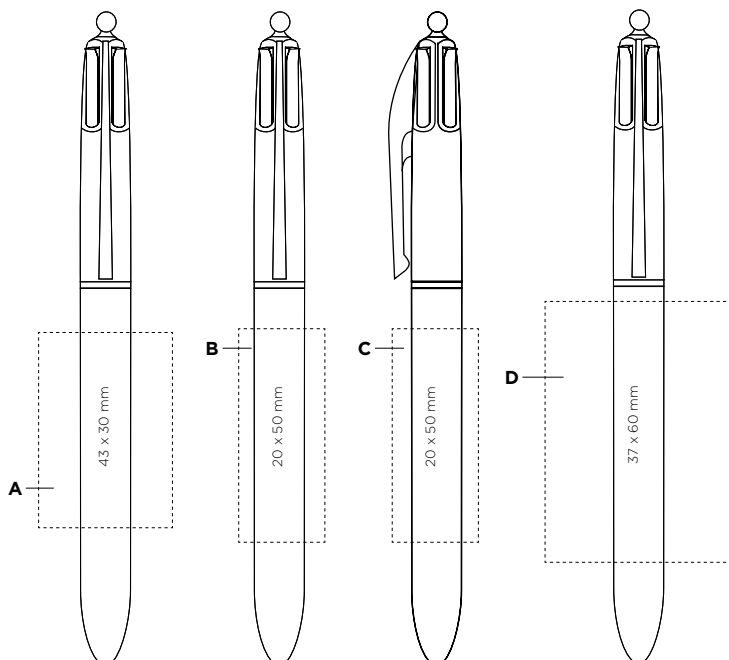

	Prix (€)							
BIC® 4 Couleurs Shine	250-499	500-999	1000-2499	2500-4999	5000-9999	10000-24999	25000-49999	
1106								
SP	3,30	2,97	2,76	2,58	2,42	2,25	2,09	
LE	4,05	3,65	3,39	3,16	2,98	2,76	2,56	
LE 360°	4,60	4,14	3,85	3,59	3,38	3,13	3,02	
1107 (tour de cou)								
SP	3,71	3,34	3,10	2,91	2,73	2,56	2,39	
LE	4,46	4,02	3,73	3,49	3,29	3,07	2,86	
LE 360°	5,01	4,51	4,19	3,92	3,69	3,44	3,32	

FRAIS D'IMPRESSION SUPPLÉMENTAIRES PAR COULEUR ET POSITION

SP	0,16	0,13	0,13	0,13	0,12	0,11	0,11
-----------	------	------	------	------	------	------	------

Les prix incluent une impression sur un emplacement avec la technique spécifiée.

① Prix sur demande.

Mode d'écriture : Techniques d'impression : Emballage externe :

Bille



M



(SP) SÉRIGRAPHIE



(LE) LASER



250 ± 3,2 Kg



FABRIQUÉ
EN FRANCE

BIC® 4 Colours

Fine



BIC® 4 Colours Fine
OPAQUE - 1109
avec tour de cou - 1111



Commande minimale 250v.

Personnalisation :

BIC® 4 Colours Fine
1109

A SP: max. 4 col.

B BP: Quadrichromie

BP Texture: Quadrichromie

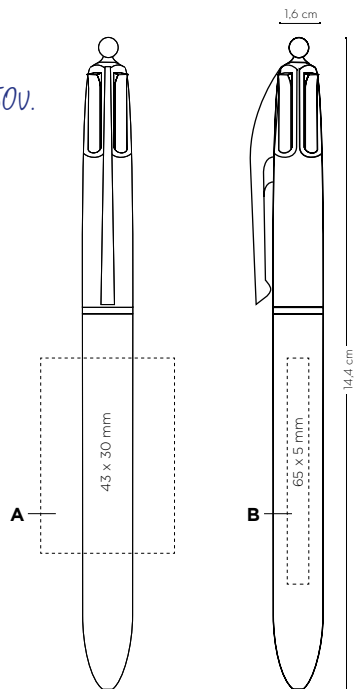

Prix (€)

BIC® 4 Colours Fine	100-249	250-499	500-999	1000-2499	2500-4999	5000-9999	10000-24999	25000-49999
1109								
SP	-	2,88	2,61	2,42	2,26	2,13	1,98	1,83
BP	3,82	3,11	2,82	2,62	2,45	2,31	2,14	1,98
1111 (tour de cou)								
SP	-	3,29	2,98	2,76	2,59	2,44	2,29	2,13
BP	4,28	3,52	3,19	2,96	2,78	2,62	2,45	2,28

FRAIS D'IMPRESSION SUPPLÉMENTAIRES PAR COULEUR ET POSITION

SP	-	0,16	0,13	0,13	0,13	0,12	0,11	0,11
BP	0,25	0,23	0,21	0,20	0,19	0,18	0,16	0,15
BP Texture	0,19	0,17	0,15	0,14	0,14	0,13	0,12	0,12

Les prix incluent une impression sur un emplacement avec la technique spécifiée.

Mode d'écriture : Techniques d'impression : Emballage externe :

Bille



F

*48h non disponible en impression numérique
Disponible sans tour de cou



(SP) SÉRIGRAPHIE



(BP) britePix™



250 ± 3,2 Kg



FABRIQUÉ EN FRANCE





BIC® 4 Colours Fluo
OPAQUE - 1114
avec tour de cou - 1116

Encre jaune fluo !



Commande minimale 250u.

Personnalisation :

- BIC® 4 Colours Fluo 1114
- A SP:** max. 4 col.
- B BP:** Quadrichromie
- BP Texture:** Quadrichromie

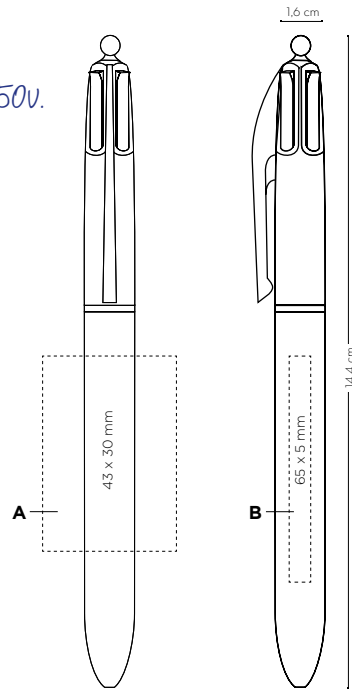

	Prix (€)							
BIC® 4 Colours Fluo	100-249	250-499	500-999	1000-2499	2500-4999	5000-9999	10000-24999	25000-49999
1114								
SP	-	3,12	2,82	2,61	2,44	2,31	2,13	1,99
BP	4,11	3,35	3,03	2,81	2,63	2,49	2,29	2,14
1116 (tour de cou)								
SP	-	3,53	3,19	2,95	2,77	2,62	2,44	2,29
BP	4,57	3,76	3,40	3,15	2,96	2,80	2,60	2,44
FRAIS D'IMPRESSION SUPPLÉMENTAIRES PAR COULEUR ET POSITION								
SP	-	0,16	0,13	0,13	0,13	0,12	0,11	0,11
BP	0,25	0,23	0,21	0,20	0,19	0,18	0,16	0,15
BP Texture	0,19	0,17	0,15	0,14	0,14	0,13	0,12	0,12

Les prix incluent une impression sur un emplacement avec la technique spécifiée.

Mode d'écriture : Techniques d'impression : Emballage externe :



B



(SP) SÉRIGRAPHIE



(BP) britePix™



250 ± 3,2 Kg



FABRIQUÉ EN FRANCE



*48h non disponible en impression numérique
Disponible sans tour de cou

BIC® 4 Colours stylus



extrémité en caoutchouc pour écran tactile !

BIC® 4 Colours stylus
OPAQUE - 1112



Commande minimale 250v.

Personnalisation :

BIC® 4 Colours stylus
1112

A SP: max. 1 col.

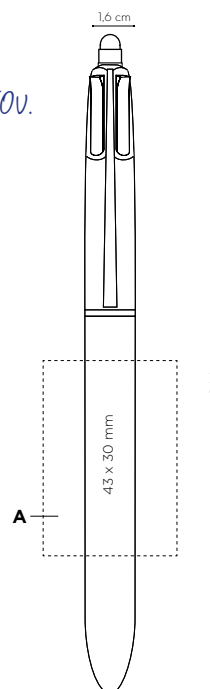

02/02

Encre de couleur



02/02



100%

Prix (€)

BIC® 4 Colours stylus 1112	250-499	500-999	1000-2499	2500-4999	5000-9999	10000-24999	25000-49999
SP	3,43	3,10	2,87	2,69	2,53	2,40	2,27

Les prix incluent la sérigraphie 1 couleur sur un emplacement.

Mode d'écriture : Techniques d'impression : Emballage externe :

Bille



M



(SP) SÉRIGRAPHIE



250 ± 3,2 Kg



BIC® 4 Colours 3+1HB



BIC® 4 Colours 3+1HB
OPAQUE - 1099



01/06

01/06

Encre de couleur



100%



Nouvelle zone d'impression !

Commande minimale 250u.

Personnalisation :
BIC® 4 Colours 3+1HB
1099
A/B LE **Nouveau !**

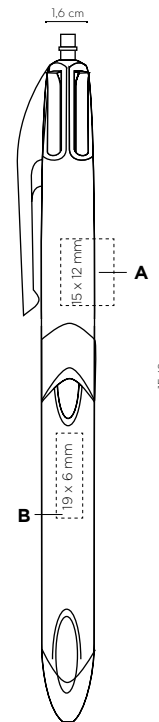

BIC® 4 Colours 3+1HB 1099	250-499	500-999	1000-2499	2500-4999	5000-9999	10000-24999	25000-49999
LE	4,34	3,91	3,64	3,39	3,20	3,08	2,97

Prix (€)

FRAIS D'IMPRESSION SUPPLÉMENTAIRES PAR EMPRÊT ET POSITION

LE	1,21	1,09	0,96	0,96	0,96	0,96	0,96
----	------	------	------	------	------	------	------

Le prix comprend 1 gravure laser en 1 position.

Mode d'écriture : Techniques d'impression : Emballage externe :

Bille & Porte-mine



M-MP Ø0,7mm



(LE) LASER



250 ± 3,5 Kg

Regardez la video



STYLOS
BIC® INSTRUMENTS D'ÉCRITURE



Stylos Métalliques

BIC® propose une sélection exclusive d'instruments d'écriture, idéale pour vos cadeaux d'affaire ou vos programmes de fidélisation et de récompense



STYLOS MÉTALLIQUES
BIC® INSTRUMENTS D'ÉCRITURE





1840



l'icône BIC® BOY est en relief



Encre de couleur

50

02

100%

Commande minimale 50v.

Personnalisation :

BIC® Attriant®

1840

A LE: clip droit et gauche

B SP: max. 1 col.

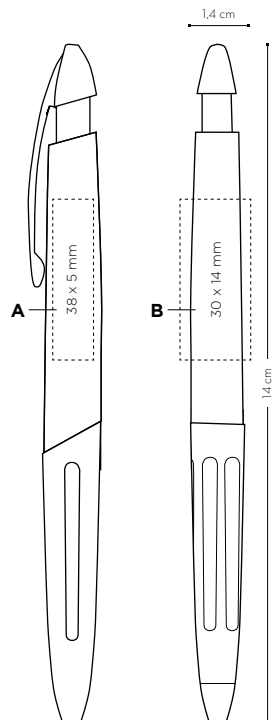

BIC® Attriant®

1840

SP

LE

	50-91	100-241	250-491	500-991	1000-2491	2500-4991	5000-9991	Prix (€)
SP	7,29	6,79	6,29	5,88	5,51	①	①	
LE	8,44	7,74	7,17	6,69	6,26	①	①	

FRAIS D'IMPRESSION SUPPLÉMENTAIRES PAR COULEUR ET POSITION

LE	1,58	1,35	1,23	1,11	0,96	①	①	
----	------	------	------	------	------	---	---	--

Les prix incluent une impression sur un emplacement avec la technique spécifiée.

① Prix sur demande.

Mode d'écriture : Emballage :

Bille



M

*48h uniquement disponible en LE



Emballage standard : Black Velvet Pouch 1 item

Techniques d'impression :



(SP) SÉRIGRAPHIE



(LE) LASER

Emballage externe :



150 ± 4,65 Kg

BIC® Protrusion Grip



Commande minimale 50v.

Personnalisation :

BIC® Protrusion Grip
1836
A LE: clip droit et gauche
B SP: max. 1 col.

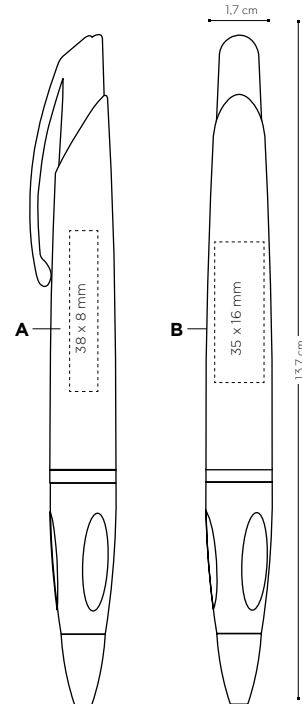

BIC® Protrusion Grip	50-91	100-249	250-499	500-999	1000-2499	2500-4999	5000-9999	Prix (€)
1836								

SP	6,98	6,49	6,01	5,62	5,26	①	①
LE	8,13	7,44	6,89	6,43	6,01	①	①

FRAIS D'IMPRESSION SUPPLÉMENTAIRES PAR COULEUR ET POSITION

LE	1,58	1,35	1,23	1,11	0,96	①	①
-----------	------	------	------	------	------	---	---

Les prix incluent une impression sur un emplacement avec la technique spécifiée.

① Prix sur demande.

Mode d'écriture : Emballage :

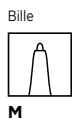

*48h uniquement disponible en LE



Emballage standard : Black Velvet Pouch 1 item

Techniques d'impression :



(SP) SÉRIGRAPHIE



(LE) LASER

Emballage externe :



150 ± 4,65 Kg

STYLOS MÉTALLIQUES
BIC® INSTRUMENTS D'ÉCRITURE

Wide Body™ Metal



1285



02



07



100%



l'icône BIC® BOY est en relief

Encre de couleur



47



*48h uniquement disponible en LE



Commande minimale 50v.

Personnalisation :

BIC® Wide Body Metal™

1285

A/B LE

C LE: clip droit, gauche et arrière

D/E/F SP: max. 1 col.

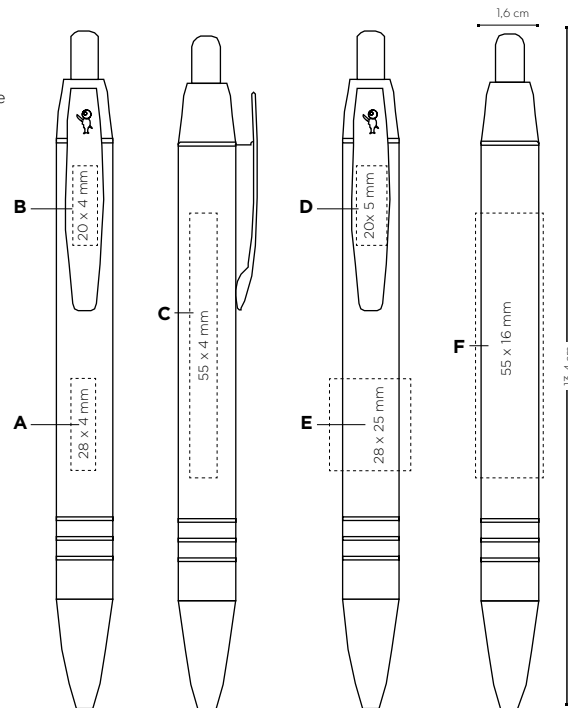

	Prix (€)						
BIC® Wide Body Metal™	50-491	100-2491	250-4991	500-9991	1000-24991	2500-49991	5000-99991
1285							
SP	5,43	5,05	4,67	4,37	4,07	①	①
LE	6,58	6,00	5,55	5,18	4,82	①	①

FRAIS D'IMPRESSION SUPPLÉMENTAIRES PAR COULEUR ET POSITION

SP	0,43	0,40	0,35	0,30	0,21	①	①
LE	1,58	1,35	1,23	1,11	0,96	①	①

Les prix incluent une impression sur un emplacement avec la technique spécifiée.

① Prix sur demande.

Mode d'écriture :



M



Emballage standard : Black Velvet Pouch 1 item

Techniques d'impression :



(SP) SÉRIGRAPHIE



(LE) LASER

Emballage externe :



150 ± 4 Kg

Tri-Tone Twist



1943



08

Encre de couleur



25

100%



02

l'icône BIC® BOY est en relief

BIC® INSTRUMENTS D'ÉCRITURE
STYLOS MÉTALLIQUES

*48h uniquement disponible en LE



Commande minimale 50v.

Personnalisation :

BIC® Tri-Tone Twist

1943

A LE: clip droit, gauche et arrière

B LE: droite, gauche, arrière
& centre couronné **

C SP: max. 1 col.

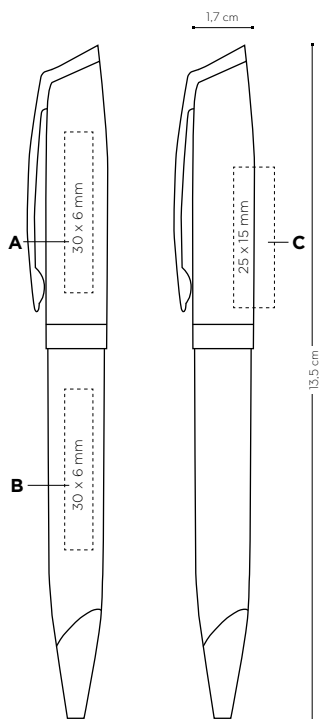

	Prix (€)						
BIC® Tri-Tone Twist	50-491	100-2491	250-4491	500-4491	1000-24491	2500-44491	5000-44491
1943							
SP	8,06	7,50	6,95	6,51	6,10	①	①
LE	9,21	8,45	7,83	7,32	6,85	①	①

FRAIS D'IMPRESSION SUPPLÉMENTAIRES PAR COULEUR ET POSITION

LE	1,58	1,35	1,23	1,11	0,96	①	①
-----------	------	------	------	------	------	---	---

Les prix incluent une impression sur un emplacement avec la technique spécifiée.

① Prix sur demande.

Mode d'écriture : Emballage :

Bille



M

** LE non disponible sur le corps bleu



Emballage standard : Black Velvet Pouch 1 item

Techniques d'impression :



(SP) SÉRIGRAPHIE



(LE) LASER

Emballage externe :



150 ± 4,65 Kg

Gel-ocity® Illusion

Le stylo BIC® Gel-ocity® Illusion® est un stylo à encre gel effaçable. Écrivez, effacez et réécrivez encore !





ROLLERS
BIC INSTRUMENTS D'ÉCRITURE



BIC Gel-ocity® Illusion

Nouveau !



OPAQUE - 1136



03

Encre de couleur



05



04



02



L'encre effaçable se base sur technologie thermosensible : écrivez, effacez et réécrivez encore

BIC INSTRUMENTS D'ÉCRITURE

ROLLERS

Disponible uniquement en: UE (incluant la Norvège, la Suisse et la Turquie)



Commande minimale 250v.

Personnalisation :

BIC® Gel-Ocity® Illusion

1136

A SP: max. 1 col.

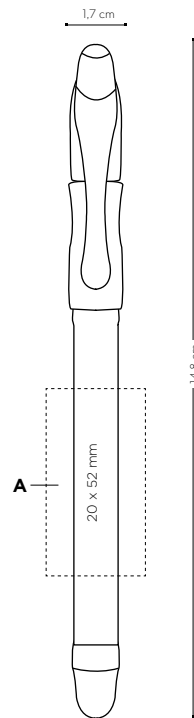

	Prix (€)						
BIC® Gel-Ocity® Illusion	250-499	500-999	1000-2499	2500-4999	5000-9999	10000-24999	25000-49999
1136							
SP	2,57	2,34	2,18	2,03	1,91	①	①

Les prix incluent la sérigraphie 1 couleur sur un emplacement.

① Prix sur demande.

Mode d'écriture : Techniques d'impression : Emballage externe :

Gel effaçable



G Ø0,7mm



(SP) SÉRIGRAPHIE



500 ± 5,87 Kg



Atlantis® Gel

La famille de produits Atlantis® accueille une version encre gel ultra-douce à l'aspect moderne, dotée d'un clip métallique et d'attributs chromés.

1062



l'icône BIC® BOY est en relief



65

Commande minimale 250v.

Personnalisation :

BIC® Atlantis® Gel
1062

A PD: droite, gauche ou
arrière clip max 1 col.

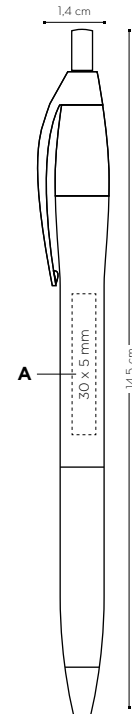

Encre de couleur



40

Prix (€)

BIC® Atlantis® Gel	250-499	500-999	1000-2499	2500-4999	5000-9999	10000-24999	25000-49999
1062							
PD	1,54	1,39	1,29	1,20	1,13	①	①

FRAIS D'IMPRESSION SUPPLÉMENTAIRES PAR COULEUR ET POSITION

PD	0,16	0,13	0,13	0,13	0,12	①	①
-----------	------	------	------	------	------	---	---

Les prix incluent la tamponographie monochrome sur un emplacement.

① Prix sur demande.

Mode d'écriture :

Techniques d'impression :

Emballage externe :

Gel



GØ0,7mm



(PD) TAMPOGRAPHIE



250 ± 3 Kg

Grip Roller

Profitez d'une expérience d'écriture fluide. Parfait pour les droitiers comme pour les gauchers, il glisse facilement sur le papier et ne fait pas de tâches grâce à son encre à séchage rapide.





ROLLERS
BIC INSTRUMENTS D'ÉCRITURE



BIC® Grip Roller



l'icône BIC® BOY est en relief



BIC® Grip Roller
1187

BIC® INSTRUMENTS D'ÉCRITURE

ROLLERS



Encre de couleur



BIC® Grip Roller Gold
1195



02/26

Commande minimale 250v.

Personnalisation :

BIC® Grip Roller
1195
1187 (gold)
A/B SP: max. 3 col.

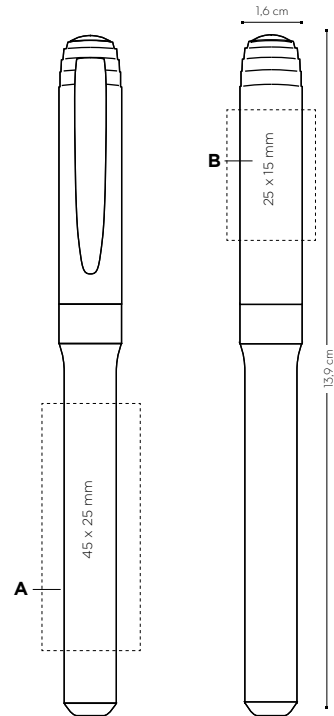

BIC® Grip Roller
1195/1187

250-499 500-999 1000-2499 2500-4999 5000-9999 10000-24999 25000-49999

Prix (€)

SP	1,63	1,47	1,37	1,27	1,19	①	①
----	------	------	------	------	------	---	---

FRAIS D'IMPRESSION SUPPLÉMENTAIRES PAR COULEUR ET POSITION

SP	0,16	0,13	0,13	0,13	0,12	①	①
----	------	------	------	------	------	---	---

Les prix incluent la tampographie monochrome sur un emplacement.

① Prix sur demande.

Mode d'écriture :

Techniques d'impression :

Emballage externe :

Stylo roller



RØ0,7mm



(SP) SÉRIGRAPHIE



250 ± 3 Kg



Intensity® Gel Clic

Stylo-bille gel ultra doux, disponible avec une encre bleue ou noire. Mécanisme de rétraction automatique pour éviter les tâches sur les poches.

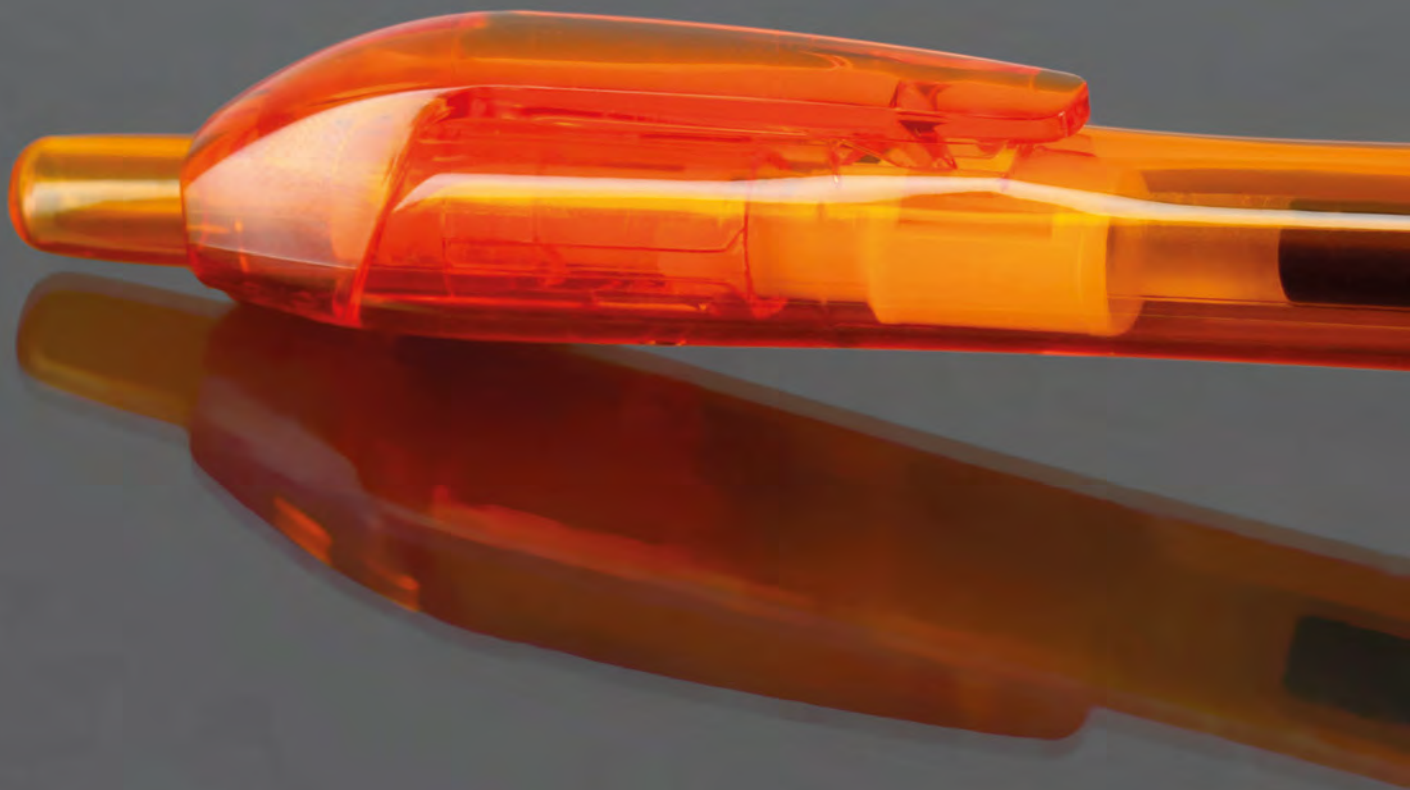



ROLLERS
BIC® INSTRUMENTS D'ÉCRITURE



BIC® Intensity® Gel Clic



OPAQUE - 1196

TRANSPARENT - 1196



l'icône BIC® BOY est en relief



BIC® INSTRUMENTS D'ÉCRITURE

ROLLERS



Encre de couleur

*Jusqu'à épuisement du stock



Commande minimale 250u.

Personnalisation :

BIC® Intensity® Gel Clic

1196

A SP: max. 2 col.

B SP: max. 4 col.

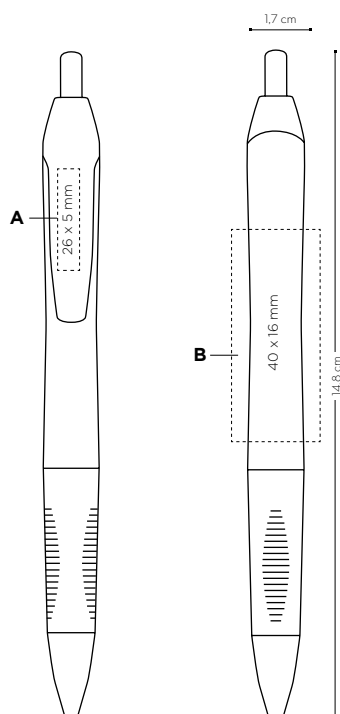

	Prix (€)						
BIC® Intensity® Gel Clic	250-499	500-999	1000-2499	2500-4999	5000-9999	10000-24999	25000-49999
1196							
SP	2,64	2,40	2,22	2,07	1,95	①	①
FRAIS D'IMPRESSION SUPPLÉMENTAIRES PAR COULEUR ET POSITION							
SP	0,16	0,13	0,13	0,13	0,12	①	①
Les prix incluent la sérigraphie 1 couleur sur un emplacement.							
① Prix sur demande.							

Mode d'écriture : Techniques d'impression : Emballage externe :

Gel



GØ0,7mm



(SP) SÉRIGRAPHIE



250 ± 3,7 Kg



Roller Glide® PRO

Encre à base d'eau pour un plus grand confort d'écriture. Le capuchon peut être retiré pendant plus de 2 heures. Corps de couleur translucide permettant de voir le niveau d'encre.



BIC® Roller Glide® PRO



1197



Encre de couleur

Commande minimale 250v.

Personnalisation :

BIC® Roller Glide PRO
1197
A SP: max 1 col.

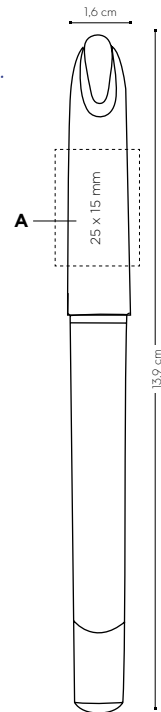

	Prix (€)						
BIC® Roller Glide PRO	250-499	500-999	1000-2499	2500-4999	5000-9999	10000-24999	25000-49999
1197							
SP	1,85	1,68	1,56	1,47	1,38	①	①

Les prix incluent la sérigraphie 1 couleur sur un emplacement.

① Prix sur demande.

Mode d'écriture : Techniques d'impression : Emballage externe :

Stylo roller



R0,7mm



(SP) SÉRIGRAPHIE



400 ± 2,6 Kg

ROLLERS
BIC® INSTRUMENTS D'ÉCRITURE



 XS Finestyle

Roller super doux avec pointe feutre fine. Désormais disponible aussi en version britePix™ sur le clip.



BIC INSTRUMENTS D'ÉCRITURE

ROLLERS







OPAQUE - 1851

OPAQUE / TRANSPARENT
1851

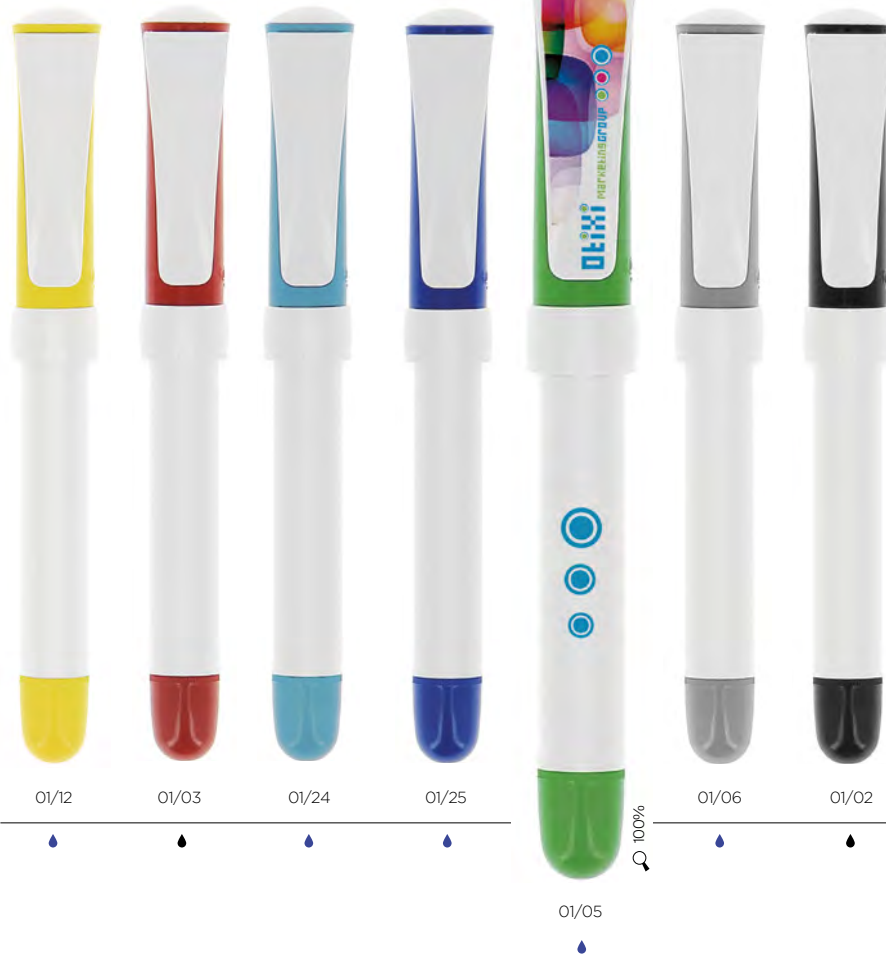

BIC INSTRUMENTS D'ÉCRITURE
ROLLERS

Encre de couleur

100%

*48h non disponible en impression britePix™



Commande minimale 250u.

Personnalisation :

BIC® XS Finestyle

1851

A PD: max 2 col.

B SP: max 2 col.

C BP: Quadrichromie

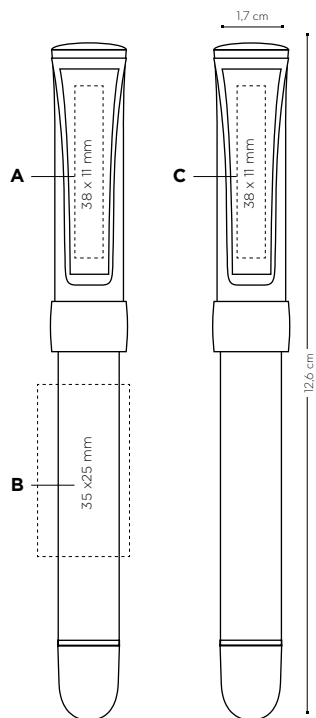

BIC® XS Finestyle	250-499	500-999	1000-2499	2500-4999	5000-9999	10000-24999	25000-49999	Prix (€)
1851								
SP/PD	1,71	1,56	1,46	1,36	1,26	①	①	
BP	1,94	1,77	1,66	1,55	1,44	①	①	

FRAIS D'IMPRESSION SUPPLÉMENTAIRES PAR COULEUR ET POSITION

SP/PD	0,16	0,13	0,13	0,13	0,12	①	①
BP Texture	0,17	0,15	0,14	0,14	0,13	①	①

Les prix incluent une impression sur un emplacement avec la technique spécifiée.

① Prix sur demande.

Injection d'une couleur spécifique :

≥ 10.000 unités

Mode d'écriture :

Techniques d'impression :

Emballage externe :

Pointe fine



FSØ0,7mm



(SP) SÉRIGRAPHIE



(PD) TAMPOGRAPHIE



(BP) britePix™



250 ± 2,8 Kg



FABRIQUÉ
EN ESPAGNE

Brite Liner® Grip

Donnez de l'impact à votre message de précision et du contrôle à votre écriture, grâce au grip en caoutchouc.



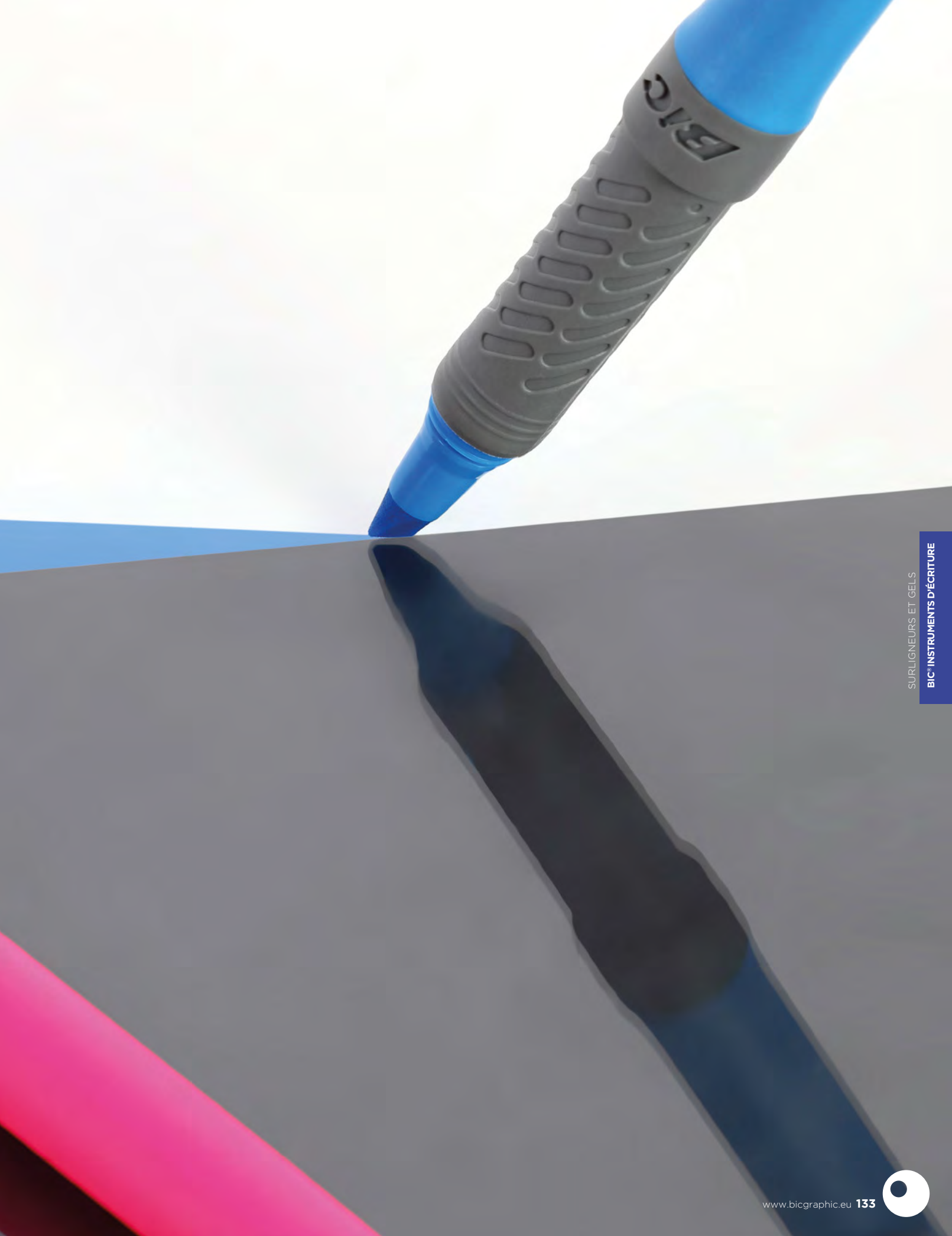

SURLIGNEURS ET GELS
BIC® INSTRUMENTS D'ÉCRITURE



BIC® Brite Liner® Grip



Nouvelle couleur !
Nouvelle couleur !
Nouvelle couleur !
Nouvelle couleur !

1192



12

10

14

100%

24

59

85

83

3G

8D

Encre de couleur

BIC® INSTRUMENTS D'ÉCRITURE
 SURLIGNEURS ET GELS



Commande minimale 250u.

Personnalisation :

BIC® Brite Liner® Grip

1192

A/B SP: max. 3 col.

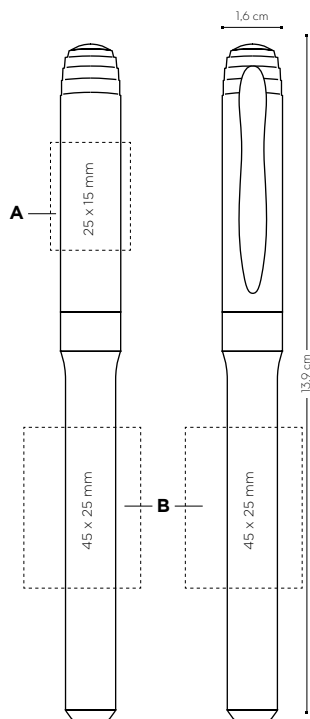

	Prix (€)						
BIC® Brite Liner® Grip	250-499	500-999	1000-2499	2500-4999	5000-9999	10000-24999	25000-49999
1192							
SP	1,46	1,35	1,23	1,15	1,08	①	①

FRAIS D'IMPRESSION SUPPLÉMENTAIRES PAR COULEUR ET POSITION

SP	0,16	0,13	0,13	0,13	0,12	①	①
-----------	------	------	------	------	------	---	---

Les prix incluent la sérigraphie 1 couleur sur un emplacement.

① Prix sur demande.

Mode d'écriture : Techniques d'impression : Emballage externe :

Highlighter



HL



(SP) SÉRIGRAPHIE



250 ± 2,8 Kg





Les marqueurs BIC® vous proposent des produits spécifiquement conçus pour écrire avec une haute visibilité, et sur des surfaces ou des matériaux sur lesquels d'autres instruments d'écriture ne peuvent être utilisés. Donnez de la visibilité à vos idées et exprimez-vous sur n'importe quelle surface avec les marqueurs BIC®.



BIC® INSTRUMENTS D'ÉCRITURE

SURLIGNEURS ET GELS





SURLIGNEURS ET GELS
BIC® INSTRUMENTS D'ÉCRITURE



BIC® Velleda® White Board Marker Fine



1651



01/03

01/04

01/02

01/05

Encre de couleur



100%

Commande minimale 500v.

Personnalisation :

BIC® Velleda® White Board Marker Fine
1651

A SP: max. 1 col.

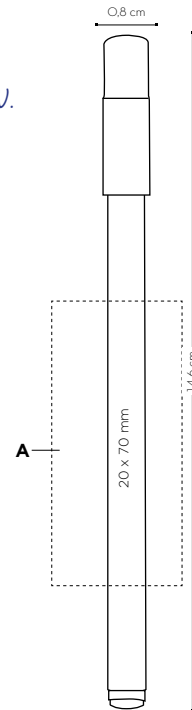

Prix (€)

BIC® Velleda® White Board Marker Fine 1651	250-499	500-999	1000-2499	2500-4999	5000-9999	10000-24999	25000-49999
SP	-	0,54	0,49	0,46	0,43	0,40	0,37

Les prix incluent la sérigraphie 1 couleur sur un emplacement.

Mode d'écriture : Techniques d'impression : Emballage externe :

Marqueur



(SP) SÉRIGRAPHIE



500 ± 3,2 Kg



FABRIQUÉ EN FRANCE



BIC Velleda White Board Marker Grip



Nouvelle couleur !
Nouvelle couleur !
Nouvelle couleur !



1213



Encre de couleur

01/03

01/05

01/04

01/02

100%

Commande minimale 250v.

Personnalisation :

BIC® Velleda® White Board Marker Grip 1213
A/B SP: max. 3 col.

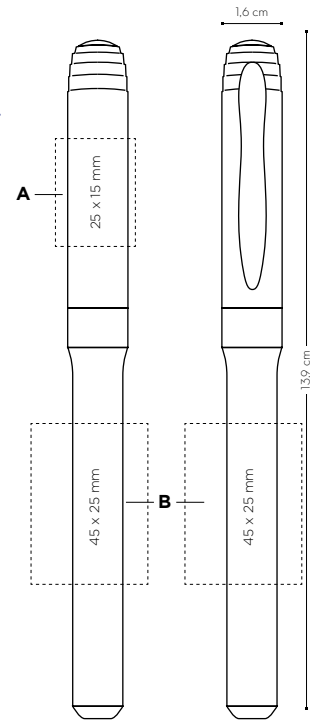

Prix (€)

BIC® Velleda® White Board Marker Grip 1213	250-499	500-999	1000-2499	2500-4999	5000-9999	10000-24999	25000-49999
SP	1,45	1,30	1,21	1,13	1,06	①	①

FRAIS D'IMPRESSION SUPPLÉMENTAIRES PAR COULEUR ET POSITION

SP	0,16	0,13	0,13	0,13	0,12	①	①
----	------	------	------	------	------	---	---

Les prix incluent la sérigraphie 1 couleur sur un emplacement.

① Prix sur demande.

Mode d'écriture : Techniques d'impression : Emballage externe :

Marqueur pour ardoise blanche



(SP) SÉRIGRAPHIE



250 ± 2,7 Kg

SURLIGNEURS ET GELS
BIC® INSTRUMENTS D'ÉCRITURE



BIC® Mark-it Permanent Marker



Nouvelle couleur !
Nouvelle couleur !

1214



Encre de couleur

01/03

01/05

01/02

01/04

100%

Commande minimale 250v.

Personnalisation :

BIC® Mark-it Permanent Marker

1214

A/B SP: max. 3 col.

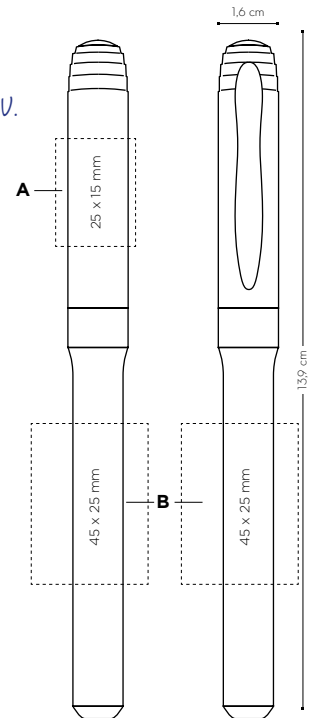

Prix (€)

BIC® Mark-it Permanent Marker

1214

SP

250-441

500-441

1000-2441

2500-4441

5000-4441

10000-2441

25000-4441

1,45

1,30

1,21

1,13

1,06

①

①

FRAIS D'IMPRESSION SUPPLÉMENTAIRES PAR COULEUR ET POSITION

SP

0,16

0,13

0,13

0,13

0,12

①

①

Les prix incluent la sérigraphie 1 couleur sur un emplacement.

① Prix sur demande.

Mode d'écriture :

Techniques d'impression :

Emballage externe :

Marqueur



MK



(SP) SÉRIGRAPHIE



250 ± 2,8 Kg



BIC® Permanent Marker **ecolutions®**



ecolutions® Fabriqué avec 51% de matériaux recyclés.
Le pourcentage est calculé sur le poids total du produit.

Ajoutez l'anneau Möbius à votre article sans frais supplémentaire. N'oubliez pas de préciser < Imprimer l'anneau Möbius > dans votre commande.
(L'anneau Möbius est imprimé par défaut dans le coin supérieur gauche)



1210



Encre de couleur

O2

100%

O2

Commande minimale 250v.

Personnalisation :

BIC® Permanent Marker **ecolutions®**
1210

A SP: max. 1 col.

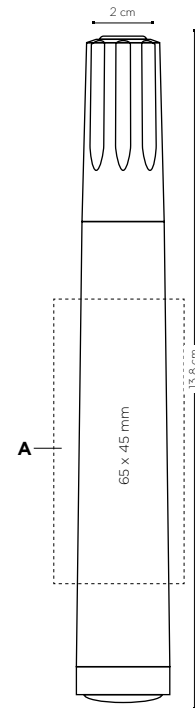

ecolutions® Fabriqué avec 51% de matériaux recyclés.

Prix (€)

BIC® Permanent Marker ecolutions® 1210	250-499	500-999	1000-2499	2500-4999	5000-9999	10000-24999	25000-49999
SP	1,71	1,56	1,44	1,35	1,26	①	①

Les prix incluent la sérigraphie 1 couleur sur un emplacement.

① Prix sur demande.

SURLIGNEURS ET GELS
BIC® INSTRUMENTS D'ÉCRITURE

Mode d'écriture : Techniques d'impression : Emballage externe :

Marqueur



(SP) SÉRIGRAPHIE



250 ± 2,6 Kg



FABRIQUÉ EN FRANCE





Toujours prêt avec ce porte-mine de grande qualité. Il est solide et la mine est résistante. Il n'a pas besoin d'être taillé et offre une écriture plus fluide et plus intense que jamais !







BIC® Matic®
OPAQUE - 1120



01/01

01/12

01/03

01/05

01/04

01/02

02/02

100%

BIC® INSTRUMENTS D'ÉCRITURE

CRAYONS





ecolutions® Fabriqué avec 65% de matériaux recyclés.
Le pourcentage est calculé sur le poids total du produit.

Ajoutez l'anneau Möbius à votre article sans frais supplémentaire. N'oubliez pas de préciser < imprimer l'anneau Möbius > dans votre commande. (L'anneau Möbius est imprimé par défaut dans le coin supérieur gauche)



CRAYONS
BIC® INSTRUMENTS D'ÉCRITURE





BIC® Matic® Quartz
OPAQUE - 1121



51/01

51/03



51/04



BIC® Matic® Quartz Metallic



51/07

51/18

BIC® Matic® Grip
OPAQUE - 1122



01/04

01/02

BIC® Matic® Grip Metallic



02/02



1D/02

Commande minimale 500v.

Personnalisation :

BIC® Matic®
1120
eColutions® 1E40

BIC® Matic®
Quartz & Metallic
1121

A SP: max. 1 col. (non disponible pour BIC® Matic® Quartz)
B/C SP: max. 2 col.

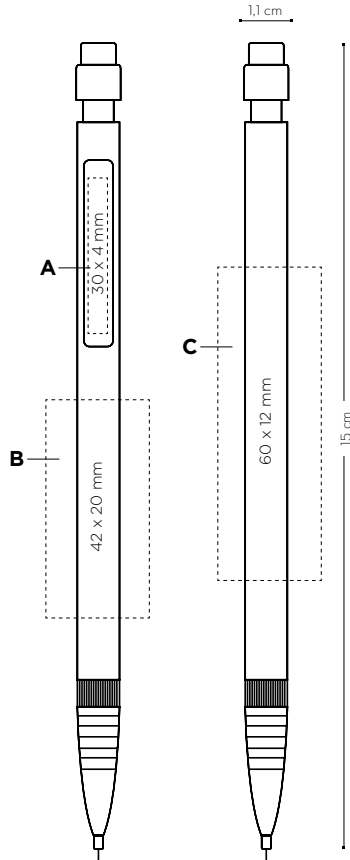

BIC® Matic® Grip &
Metallic
1122
A SP: max. 1 col.
B/C SP: max. 2 col.

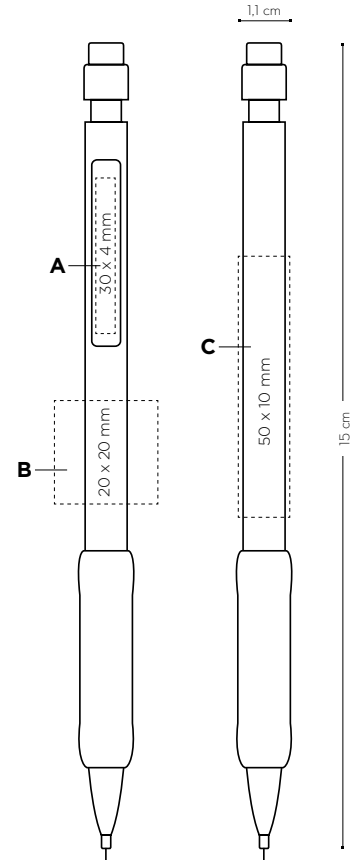

Version eColutions® et version STD au même prix !



BIC® Matic®
Quartz & Metallic
1120/eColutions® 1E40

	Prix (€)					
	500-444	1000-2444	2500-4444	5000-4444	10000-24444	25000-44444
SP	0,76	0,71	0,66	0,62	0,58	0,54
1121						
SP	0,83	0,76	0,71	0,67	0,63	0,59

FRAIS D'IMPRESSION SUPPLÉMENTAIRES PAR COULEUR ET POSITION

SP	0,13	0,13	0,13	0,12	0,11	0,11
-----------	------	------	------	------	------	------

Les prix incluent la sérigraphie 1 couleur sur un emplacement.

BIC® Matic® Grip &
Metallic
1122

	Prix (€)					
	500-444	1000-2444	2500-4444	5000-4444	10000-24444	25000-44444
SP	0,91	0,85	0,80	0,74	0,69	0,64

FRAIS D'IMPRESSION SUPPLÉMENTAIRES PAR COULEUR ET POSITION

SP	0,13	0,13	0,13	0,12	0,11	0,11
-----------	------	------	------	------	------	------

Les prix incluent la sérigraphie 1 couleur sur un emplacement.

Mode d'écriture : Techniques d'impression : Emballage externe :



MP
Ø0,7mm



(SP) SÉRIGRAPHIE



500 ± 3,1 Kg



FABRIQUÉ
EN FRANCE

Crayon papier en résine synthétique, sans bois, qui ne fait pas d'écharde en cas de casse. Mine graphite HB ultra-résistante qui s'efface facilement !





CRAYON PAPIER BOUT COUPE
1150

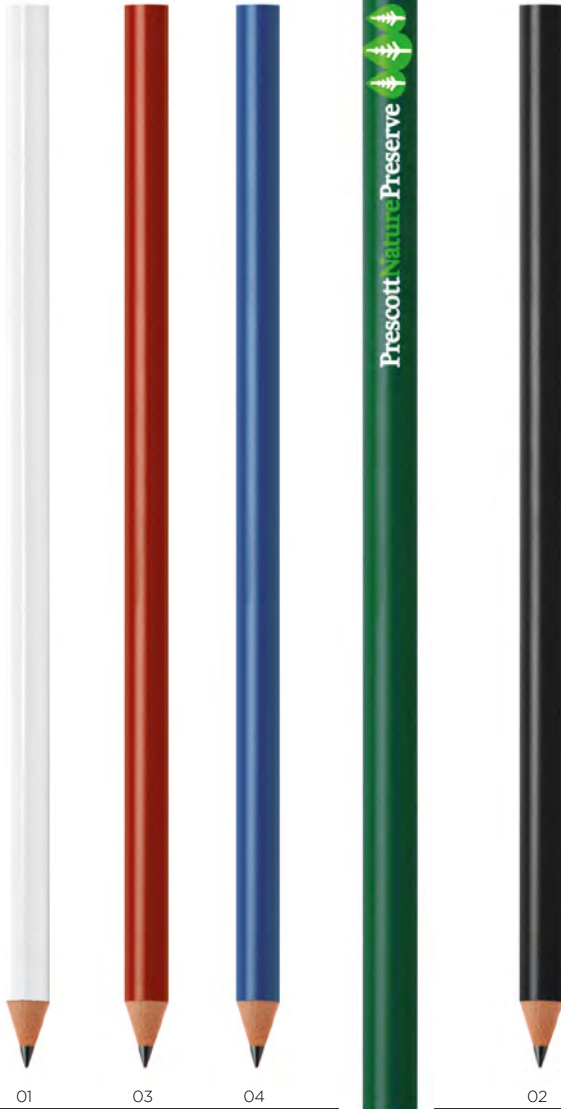

01

03

04

20

02

CRAYON PAPIER AVEC GOMME
1151



01

03

04

20

02



100%

100%



CRAYONS
BIC® INSTRUMENTS D'ÉCRITURE



Impression numérique!

Digital
CRAYON PAPIER
1150



100%

01

Metallic Digital
CRAYON PAPIER
1962



100%

47

Digital
CRAYON PAPIER
AVEC GOMME - 1151



100%

01

Metallic Digital
CRAYON PAPIER
AVEC GOMME - 1960



100%

47

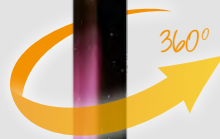

Commande minimale 500v.

Combinaison de couleurs standards

**MIX &
MATCH**



Gomme

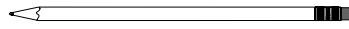

Virole

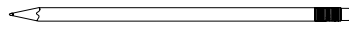

Corps

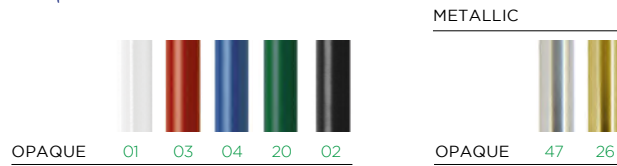

CRAYON PAPIER
BOUT COUPE



Fabriqué avec
54% de matériaux
recyclés.

CRAYON PAPIER
AVEC GOMME



Fabriqué avec
46% de matériaux
recyclés.

Le pourcentage est calculé sur le poids total du produit.

Ajoutez l'anneau Möbius à votre article sans frais supplémentaire. N'oubliez pas de préciser < imprimer l'anneau Möbius > dans votre commande.

(L'anneau Möbius est imprimé par défaut dans le coin supérieur gauche)

Mode d'écriture : Techniques d'impression : Emballage externe :



PC
HB Ø2,3mm



(SP) SÉRIGRAPHIE



(DG) NUMÉRIQUE



500 ± 3,5 Kg



FABRIQUÉ
EN FRANCE



BIC[®] EVOLUTION[®] ecolutions[®]
 CRAYON BOUT COUPÉ
 1150

BIC[®] EVOLUTION[®] ecolutions[®]
 CRAYON AVEC GOMME
 1151

A SP: max. 1 col.
B SP: max. 2 col.

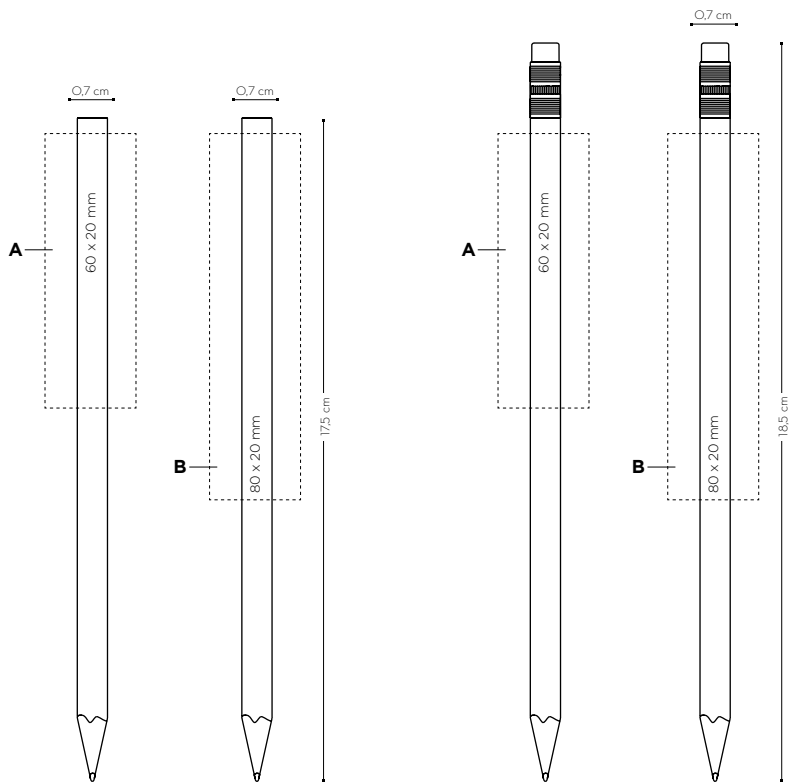

BIC[®] INSTRUMENTS D'ÉCRITURE
 CRAYONS

	Prix (€)					
	500-1111	1000-2441	2500-4441	5000-4441	10000-2441	25000-4441
CRAYON AVEC BOUT COUPÉ / 1150						
SP	0,43	0,41	0,38	0,36	0,34	0,32
CRAYON AVEC GOMME / 1151						
SP	-	0,73	0,68	0,60	0,56	0,52
FRAIS D'IMPRESSION SUPPLÉMENTAIRES PAR COULEUR ET POSITION						
SP	0,13	0,13	0,13	0,12	0,11	0,11

Les prix incluent la sérigraphie 1 couleur sur un emplacement.

Emballage externe :



BIC® Evolution® **ecolutions®**
 CRAYON BOUT COUPE
 1150 Digital
 1962 Metallic Digital

BIC® Evolution® **ecolutions®**
 CRAYON AVEC GOMME
 IMPRESSION NUMERIQUE
 1151
 CRAYON AVEC GOMME IMPRESSION
 NUMERIQUE FINITION METALLIQUE
 1960

A DG: Numérique (zone image)
B DG: Numérique (zone texte)

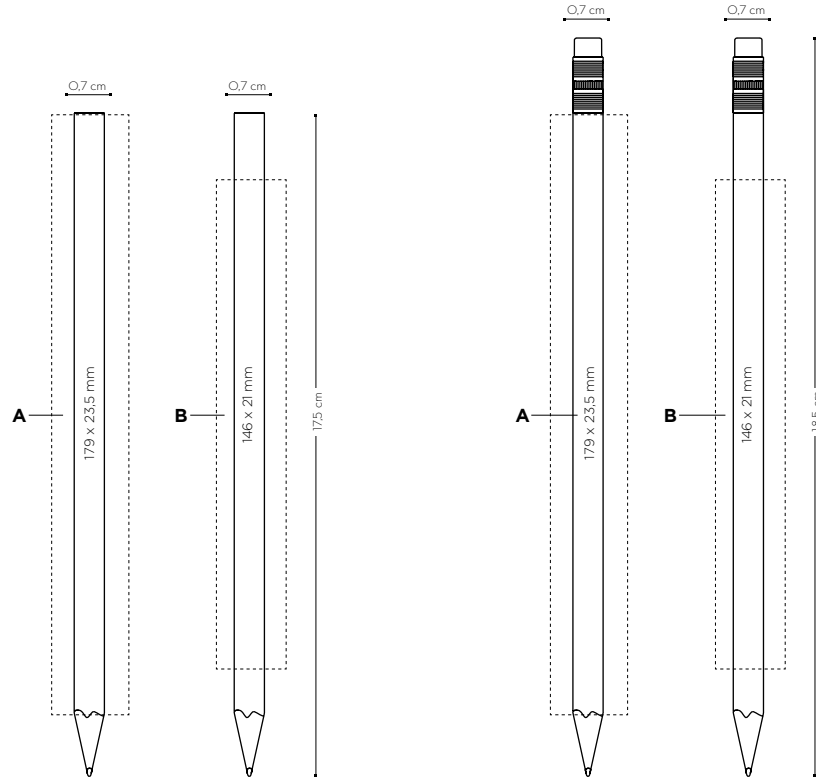

Prix (€)

BIC® Evolution® **ecolutions®** 250-499 500-999 1000-2499 2500-4999 5000-9999 10000-24999 25000-49999

CRAYON BOUT COUPE IMPRESSION NUMERIQUE / 1150

DG	-	0,67	0,64	0,59	0,55	①	①
-----------	---	------	------	------	------	---	---

CRAYON BOUT COUPE IMPRESSION NUMERIQUE FINITION METALLIQUE / 1962

DG	-	0,80	0,75	0,69	0,64	①	①
-----------	---	------	------	------	------	---	---

CRAYON AVEC GOMME IMPRESSION NUMERIQUE / 1151

DG	-	0,97	0,91	0,85	0,79	①	①
-----------	---	------	------	------	------	---	---

CRAYON AVEC GOMME IMPRESSION NUMERIQUE FINITION METALLIQUE / 1960

DG	-	1,10	1,03	0,96	0,89	①	①
-----------	---	------	------	------	------	---	---

Les prix incluent l'impression numérique sur le corps.

① Prix sur demande.

Emballage externe :

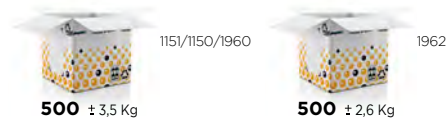

FABRIQUÉ
 EN FRANCE

Sprout®



Les crayons Sprout personnalisables sont utilisés par les entreprises et les organisations du monde entier pour communiquer leur respect de l'environnement. Une fois que le crayon est trop court pour écrire, plantez-le et regardez votre message se transformer en superbe pot d'herbes aromatiques, de fleurs ou de légumes.



SPROUT™





SPROUT™



Sprouta Pencil

Combinez-les!

53062



Crayon neutre



Crayon imprimé

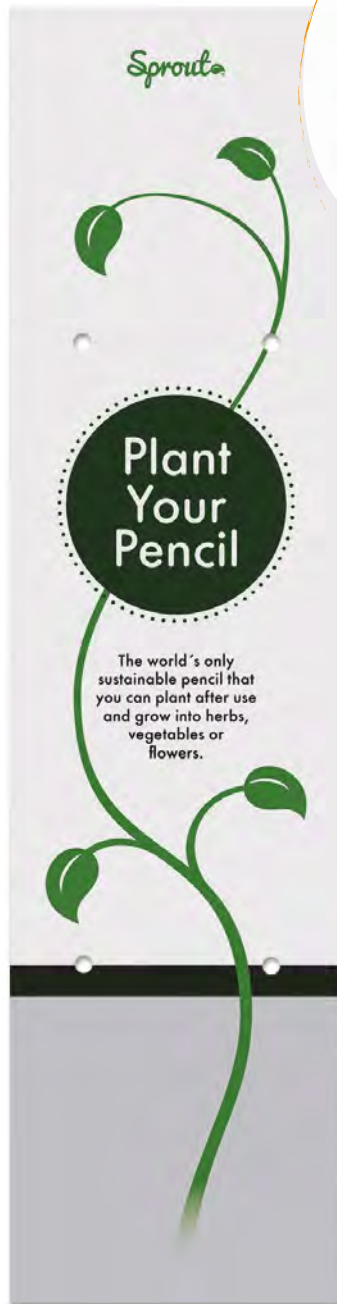

Emballage individuel standard

Emballage non personnalisable



arrière

Emballage personnalisable !

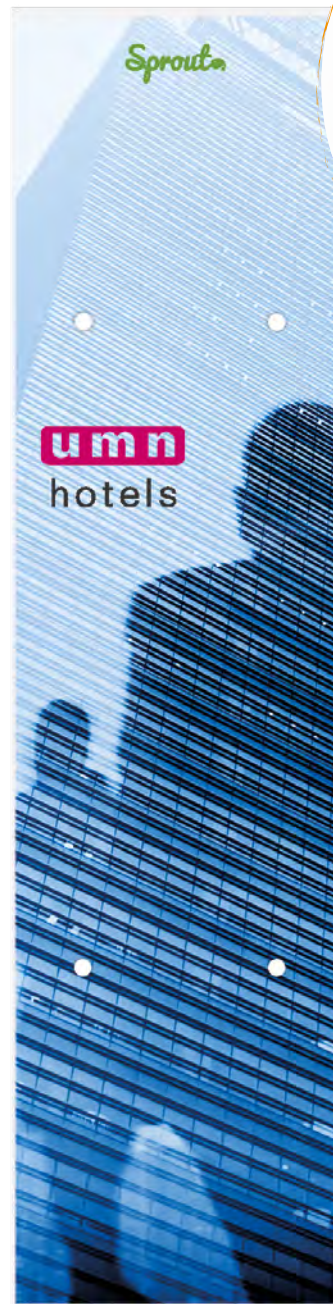

Emballage individuel personnalisé

80%



Commande minimale 500

Commande minimale 1000 (Crayon non imprimé + emballage en carton personnalisé)

Personnalisation :

Sprout™ Pencil

53062

A LE

B DG: Numérique

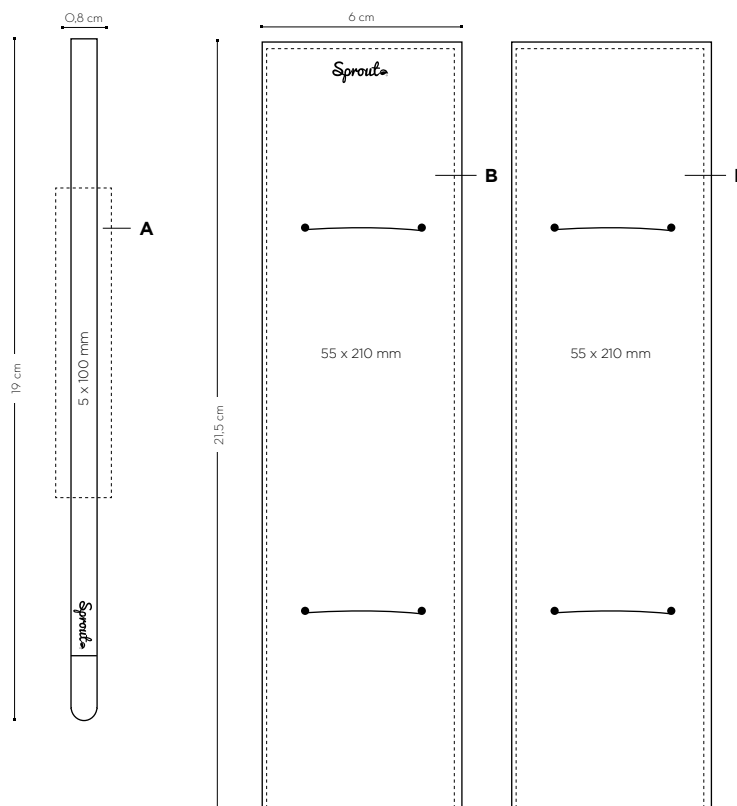

Mode d'écriture : Techniques d'impression : Emballage externe :

crayon



PC
HB Ø2,3mm



(DG) NUMÉRIQUE



(LE) LASER



500 ± 2,5 Kg Seulement crayon
± 5 Kg Avec emballage en carton

Regardez la video



 **COLOURING**

Set de 6 crayons aux couleurs vives sous les célèbres marques BIC® : PLASTIDECOR®, EVOLUTION® et VISA®. Présenté dans une pochette carton totalement personnalisable. Un article de promotion idéal pour les enfants et les ados !

BIC® PLASTIDECOR® set of 6 crayons



COLOURING CRAYONS 1201



100%

Commande minimale 500v.

Personnalisation :

Set BIC® PLASTIDECOR®
de 6 crayons
1201

A DG: Numérique

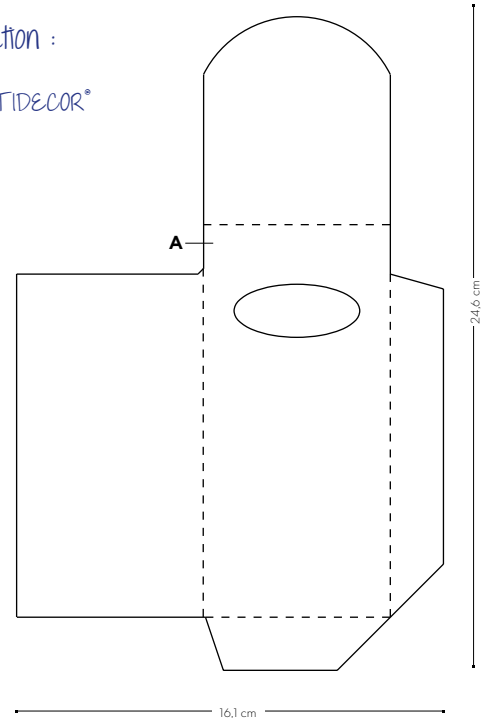

COLOURING
BIC® INSTRUMENTS D'ÉCRITURE

Prix (€)

Set BIC® PLASTIDECOR® de 6 crayons 1201	500-444	1000-2444	2500-4444	5000-4444	10000-24444	25000-44444
DG	3,17	2,39	1,96	1,71	①	①

Toute la gamme BIC® Colouring inclut l'impression en numérique sur la pochette en carton.

① Prix sur demande.

Mode d'écriture : Emballage : Techniques d'impression : Emballage externe :



01



(DG) NUMÉRIQUE



84 ± 3,8 Kg



FABRIQUÉ
EN FRANCE

BIC® Visa® set of 6 felt pens



*Except black ink
*Sauf l'encre noire



CRAYONS FEUTRE 1203



Commande minimale 500v.

Personnalisation :

BIC® VISA® Ensemble de 6
feutres
1203

A DG: Numérique

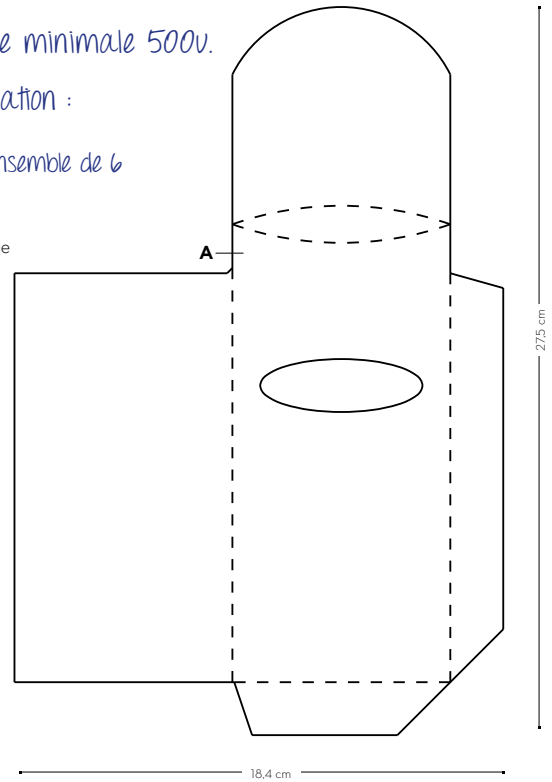

Prix (€)

BIC® VISA® Ensemble de 6 feutres 1203	500-499	1000-2499	2500-4999	5000-9999	10000-24999	25000-49999
DG	4,52	3,67	3,23	2,86	①	①

Toute la gamme BIC® Colouring inclut l'impression en numérique sur la pochette en carton.

① Prix sur demande.

Mode d'écriture :



Techniques d'impression :



(DG) NUMÉRIQUE

Emballage externe :



BIC® EVOLUTION® eCOLutions®

Set of 6 colouring pencils

CRAYONS DE COULEUR 1202



*Fabriqué avec 50% de matériaux recyclés.

80%

facile à affûter!



Commande minimale 500v.

Personnalisation :

BIC® Evolution® eCOLutions®
Ensemble de 6 crayons de couleur
1202

A DG: Numérique

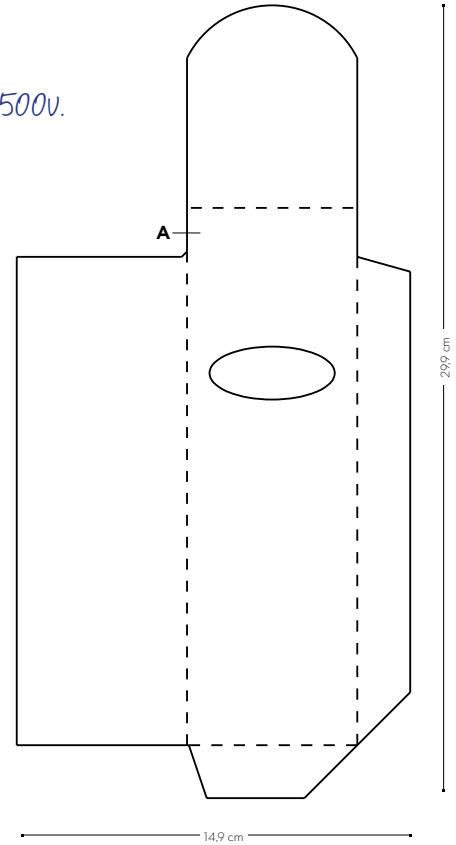

Prix (€)

BIC® evolution® eCOLutions® Ensemble de 6 crayons de couleur	500-999	1000-2499	2500-4999	5000-9999	10000-24999	25000-49999
1202						
DG	3,33	2,51	2,06	1,80	①	①

Toute la gamme BIC® Colouring inclut l'impression en numérique sur la pochette en carton.

① Prix sur demande.

Mode d'écriture :



01

Techniques d'impression :



(DG) NUMÉRIQUE

Emballage externe :



60 ± 2.6 Kg



FABRIQUÉ EN FRANCE

COLOURING
BIC® INSTRUMENTS D'ÉCRITURE



Set of 6 colouring pencils

Saviez-vous que ?

Conté® en tant que marque a été créée il y a plus de 220 ans et porte le nom de son fondateur, Nicolas-Jacques Conté. Né en France en 1755, il est considéré comme l'inventeur de la mine "moderne" du crayon à papier.





Set of 6 colouring pencils



Mine résistante



couleurs vibrantes



CRAYONS DE COULEUR 1178

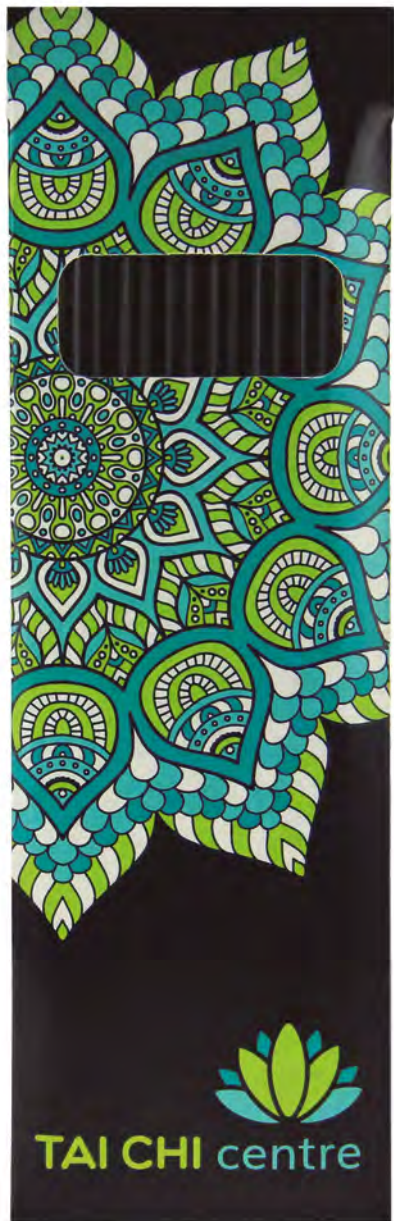

crayons sans bois

Commande minimale 500v.

Personnalisation :

Conté® Ensemble de 6 crayons de couleur

1178

A DG: Numérique

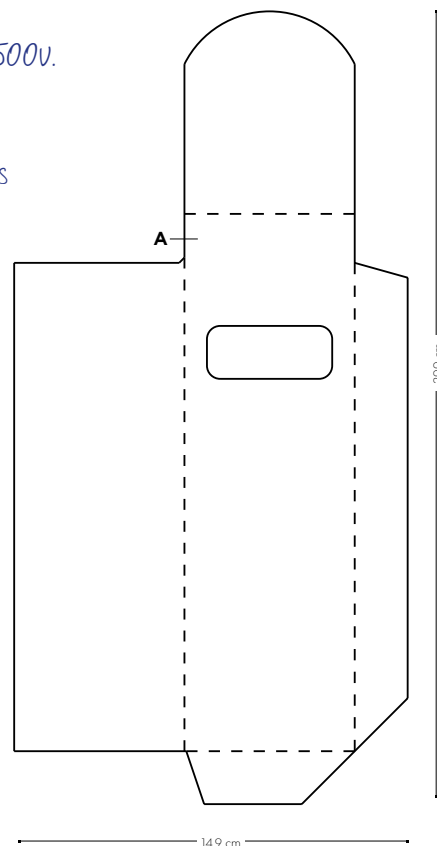

COLOURING
BIC® INSTRUMENTS D'ÉCRITURE

Prix (€)

Conté® Ensemble de 6 crayons de couleur 1178	500-4999	1000-24999	2500-49999	50000-99999	100000-249999	250000-499999
DG	3,70	2,87	2,46	2,11	①	①

Toute la gamme BIC® Colouring inclut l'impression en numérique sur la pochette en carton.

① Prix sur demande.

80%

Mode d'écriture : Emballage :



01

Techniques d'impression : Emballage externe :



(DG) NUMÉRIQUE



60 ± 2,2 Kg



FABRIQUÉ EN FRANCE



Kit de coloriage

Créez votre set de coloriage totalement personnalisé : vos crayons de couleur favoris, un cahier de coloriage pour les enfants et les adultes, et un sac en coton à cordon coulissant, orné du logo BIC®.



COLOURING
BIC INSTRUMENTS D'ÉCRITURE



Kit de coloriage

Créez votre propre combinaison

 **PLASTIDÉCOR** Kit de coloriage ,  **Visa** Kit de coloriage ou  **EVOLUTION**  Kit de coloriage



35%

Mode d'écriture :



Emballage :

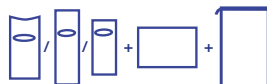

Techniques d'impression :



(SP) SÉRIGRAPHIE



(OT) TRANSFERT NUMÉRIQUE



Commande minimale 500v.

Personnalisation :

BIC® PLASTIDECOR®
Kit de coloriage
1294



Boîte

C DG: Numérique

Sac

Sans impression (sac)

A SP (sac): max 2 col.

B OT (sac): transfert numérique

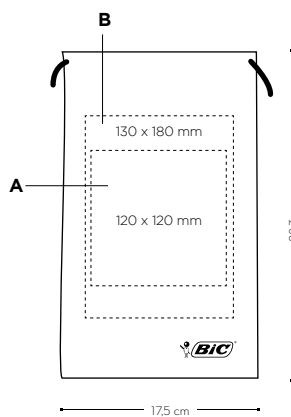

Cahier

C DG: Numérique

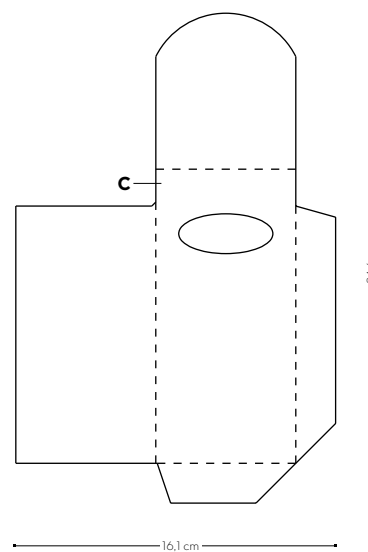
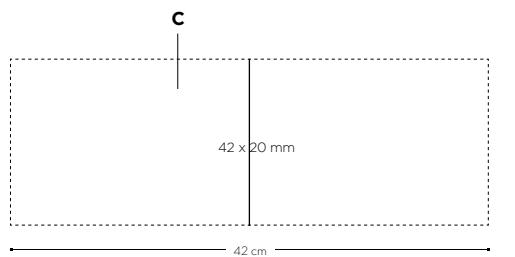

COLOURING
BIC® INSTRUMENTS D'ÉCRITURE

Prix (€)

BIC® PLASTIDECOR®
Kit de coloriage 1294

	500-499	1000-2499	2500-4999	5000-9999	10000-24999	25000-49999
Sans impression (sac)	9,82	7,07	5,65	4,74	①	①
SP (sac)	10,69	7,79	6,31	5,39	①	①
OT (sac)	11,62	8,69	7,20	6,28	①	①

FRAIS D'IMPRESSION SUPPLÉMENTAIRES PAR COULEUR ET POSITION

SP	0,87	0,72	0,66	0,65	①	①
OT	1,80	1,62	1,55	1,54	①	①

Les sets de coloriage BIC® Colouring sont composés d'une boîte de crayons de couleur, d'un cahier de coloriage et d'un sac en coton à cordon coulissant portant le logo BIC®.
Le prix inclut la personnalisation complète de la boîte à crayons et du cahier de coloriage. L'impression sur le sac est en option. Les prix ci-dessus varient en fonction de la technique de personnalisation choisie pour le sac.

① Prix sur demande.

Emballage externe :



100 ± 10,8 Kg



Kit de coloriage

BIC INSTRUMENTS D'ÉCRITURE
COLOURING

BIC® VISA®
Kit de coloriage
1291



Boîte
C DG: Numérique

Sac

Sans impression (sac)

A SP (sac): max 2 col.

B OT (sac): transfert numérique

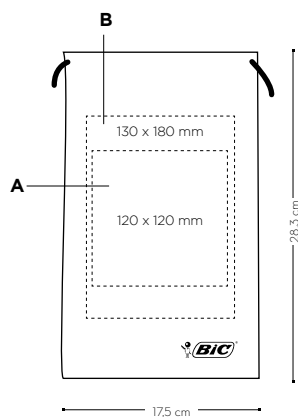

Cahier

C DG: Numérique

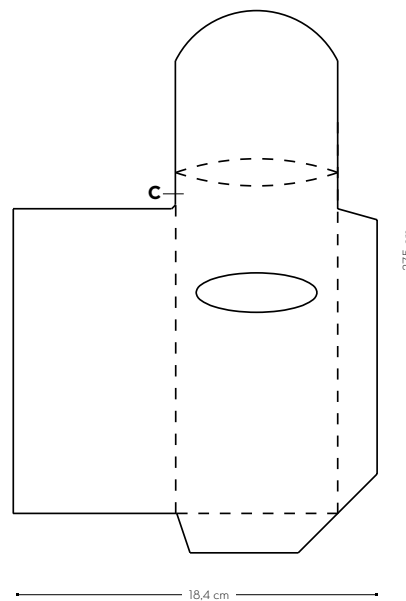
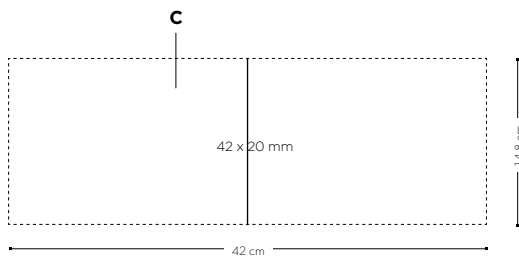

Prix (€)

BIC® VISA® Kit de coloriage 1291	500-499	1000-2499	2500-4999	5000-9999	10000-24999	25000-49999
Sans impression (sac)	11,17	8,35	6,92	5,89	①	①
SP (sac)	12,04	9,07	7,58	6,54	①	①
OT (sac)	12,97	9,97	8,47	7,43	①	①

SAC : FRAIS D'IMPRESSION SUPPLÉMENTAIRES PAR COULEUR ET POSITION

SP	0,87	0,72	0,66	0,65	①	①
OT	1,80	1,62	1,55	1,54	①	①

Les sets de coloriage BIC® Colouring sont composés d'une boîte de crayons de couleur, d'un cahier de coloriage et d'un sac en coton à cordon coulissant portant le logo BIC®.

Le prix inclut la personnalisation complète de la boîte à crayons et du cahier de coloriage. L'impression sur le sac est en option. Les prix ci-dessus varient en fonction de la technique de personnalisation choisie pour le sac.

① Prix sur demande.

Emballage externe :



100 ± 10 Kg



BIC® evolution®
Ecolutions®
Kit de coloriage
1293



Boîte
C DG: Numérique

Sac

Sans impression (sac)

A SP (sac): max 2 col.

B OT (sac): transfert numérique

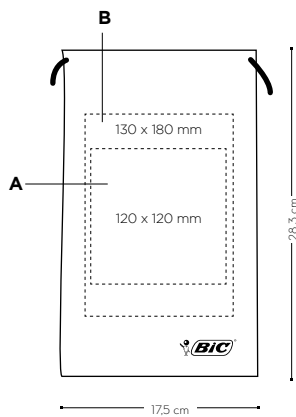

Cahier

C DG: Numérique

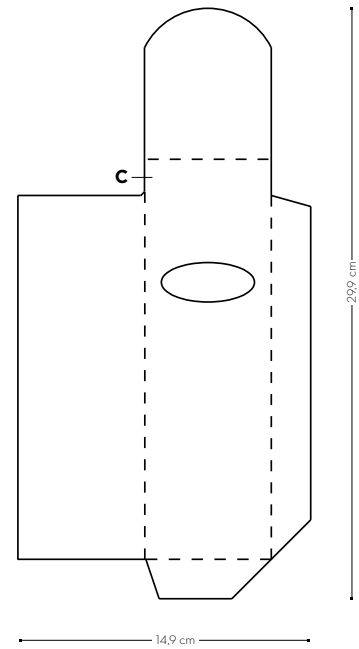
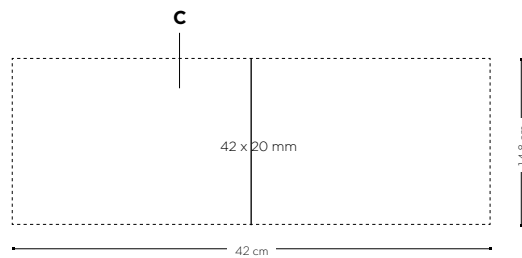

Prix (€)

BIC® evolution® ecolutions® Kit de coloriage 1293	500-441	1000-2441	2500-4441	5000-4441	10000-24441	25000-44441
Sans impression (sac)	9,98	7,19	5,75	4,83	①	①
SP (sac)	10,85	7,91	6,41	5,48	①	①
OT (sac)	11,78	8,81	7,30	6,37	①	①

SAC : FRAIS D'IMPRESSION SUPPLÉMENTAIRES PAR COULEUR ET POSITION

SP	0,87	0,72	0,66	0,65	①	①
OT	1,80	1,62	1,55	1,54	①	①

Les sets de coloriage BIC® Colouring sont composés d'une boîte de crayons de couleur, d'un cahier de coloriage et d'un sac en coton à cordon coulissant portant le logo BIC®.

Le prix inclut la personnalisation complète de la boîte à crayons et du cahier de coloriage. L'impression sur le sac est en option. Les prix ci-dessus varient en fonction de la technique de personnalisation choisie pour le sac.

① Prix sur demande.

Emballage externe :



100 ± 10,6 Kg





Kit de coloriage



BIC INSTRUMENTS D'ÉCRITURE

COLOURING

35%

Mode d'écriture :



Techniques d'impression :



(SP) SÉRIGRAPHIE



(OT) TRANSFERT NUMÉRIQUE

Emballage externe :



100 ± 10,5 Kg



Commande minimale 500v.

Personnalisation :

Kit de coloriage Conté® by BIC®
1292



Boîte
C DG: Numérique

Sac

Sans impression (sac)

A SP (sac): max 2 col.

B OT (sac): transfert numérique

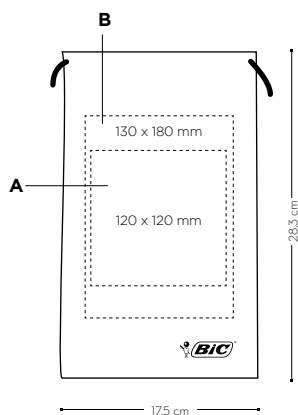

Cahier

C DG: Numérique

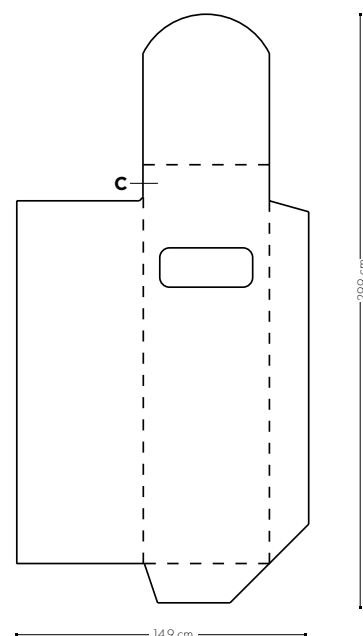
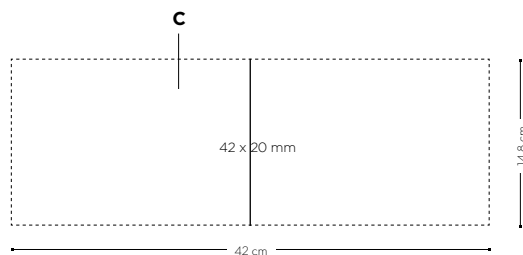

COLOURING
BIC® INSTRUMENTS D'ÉCRITURE

Kit de coloriage Conté® by BIC® 1292	Prix (€)					
	500-999	1000-2499	2500-4999	5000-9999	10000-24999	25000-49999
Sans impression (sac)	10,35	7,55	6,15	5,14	①	①
SP (sac)	11,22	8,27	6,81	5,79	①	①
OT (sac)	12,15	9,17	7,70	6,68	①	①

SAC : FRAIS D'IMPRESSIION SUPPLÉMENTAIRES PAR COULEUR ET POSITION

SP	0,87	0,72	0,66	0,65	①	①
OT	1,80	1,62	1,55	1,54	①	①

Les sets de coloriage BIC® Colouring sont composés d'une boîte de crayons de couleur, d'un cahier de coloriage et d'un sac en coton à cordon coulissant portant le logo BIC®.

Le prix inclut la personnalisation complète de la boîte à crayons et du cahier de coloriage. L'impression sur le sac est en option. Les prix ci-dessus varient en fonction de la technique de personnalisation choisie pour le sac.

① Prix sur demande.



Tipp-Ex Mini Pocket Mouse **britePix**™

Le ruban correcteur Tipp-Ex®, célèbre dans le monde entier, dans une taille compacte, idéale pour les trousse. 6 mètres de ruban plastique de large, 5 mm indéchirable, pour une application précise par les gauchers comme par les droitiers, le tout sans séchage !





1354



51



51

Commande minimale 250v.

Personnalisation :

Mini Pocket Mouse
1354

A BP: Quadrichromie

BP Texture: Quadrichromie

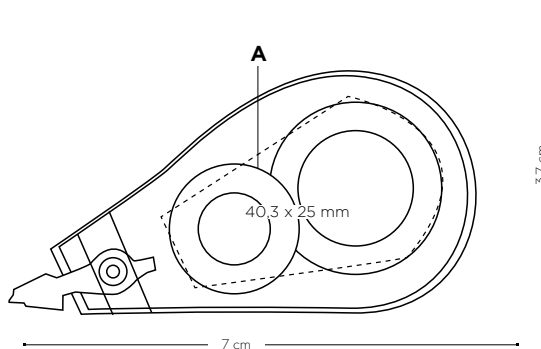

CORRECTEUR
BIC® INSTRUMENTS D'ÉCRITURE

	Prix (€)						
Tipp-Ex® Mini Pocket Mouse	250-499	500-999	1000-2499	2500-4999	5000-9999	10000-24999	25000-49999
1354							
BP	1,86	1,76	1,66	1,57	1,47	①	①

COÛTS SUPPLÉMENTAIRES :							
BP	0,70	0,64	0,59	0,56	0,54	①	①
BP Texture	0,53	0,48	0,44	0,42	0,41	①	①

Les prix incluent une impression sur un emplacement avec la technique spécifiée.

① Prix sur demande.

Mode d'écriture :

Techniques d'impression :

Emballage externe :

Regardez la video



T
6 m



(BP) britePix™



288 ± 3,2 Kg



* Source: panel GFK - Western Europe 9 - MAT juin 2018 - Ventes en valeur et volume





Autres Instruments D'écriture

BIC® a approuvé ces autres instruments d'écriture conformément aux très strictes normes de qualité et de sécurité pratiquées dans le Groupe.



Basic pen

12010

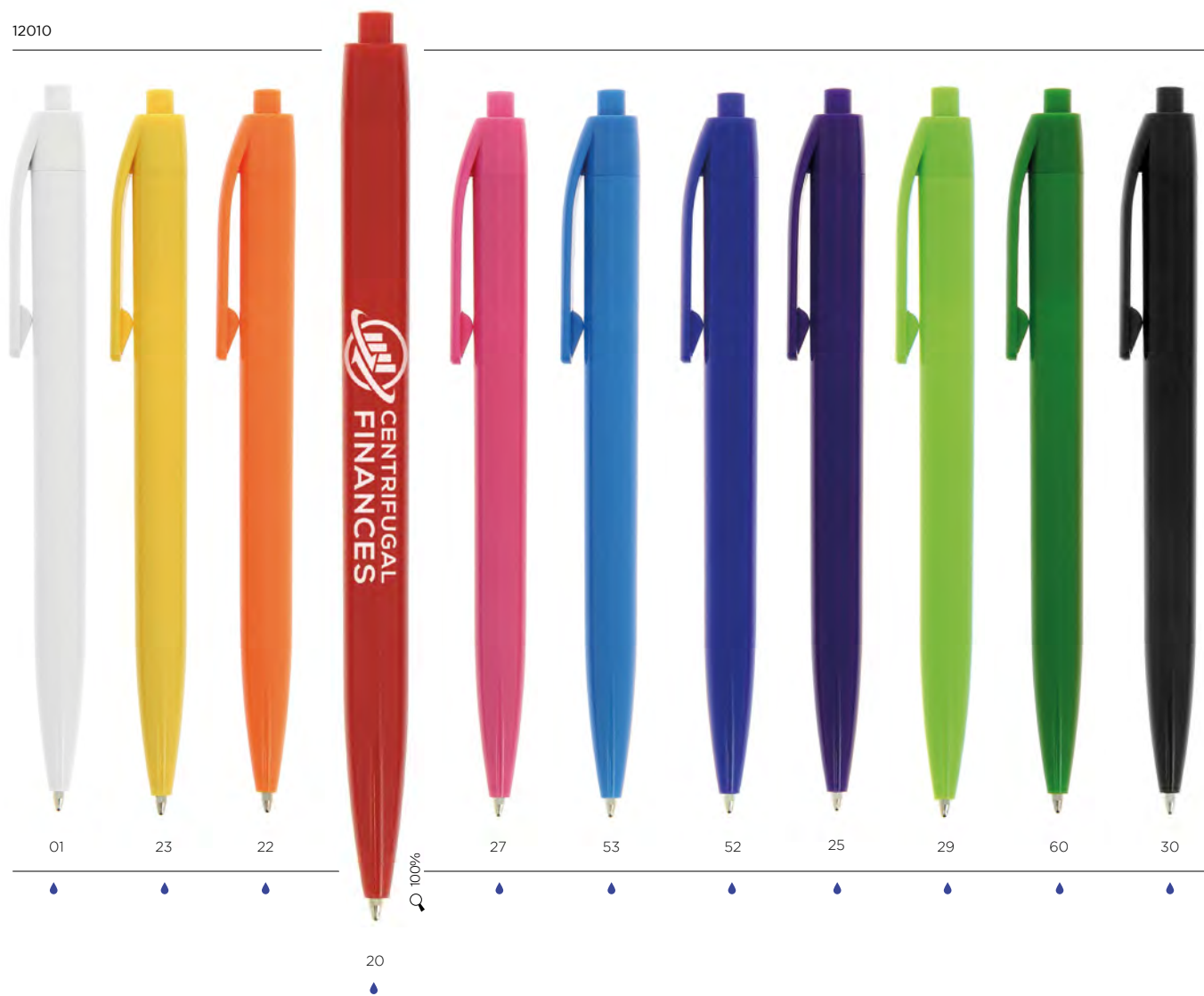

AUTRES INSTRUMENTS D'ÉCRITURE

STYLOS PLASTIQUE

Encre de couleur



Commande minimale 500u.

Personnalisation :

Basic pen
 12010
 A/B SP: max. 1 col.

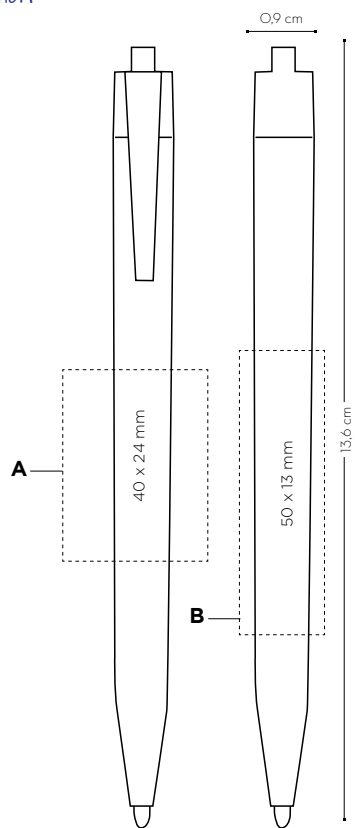

STYLOS PLASTIQUE
 AUTRES INSTRUMENTS D'ÉCRITURE

	Prix (€)					
Basic pen	500-999	1000-2499	2500-4999	5000-9999	10000-24999	25000-49999
12010						
SP	0,47	0,37	0,31	0,28	①	①

Les prix incluent la sérigraphie 1 couleur sur un emplacement.

① Prix sur demande.

Mode d'écriture :

Techniques d'impression :

Emballage externe :

Bille



M



(SP) SÉRIGRAPHIE



1000 ± 12,5 Kg



Click pen



11748

AUTRES INSTRUMENTS D'ÉCRITURE

STYLOS PLASTIQUE



Encre de couleur

White stock lasts



Commande minimale 500v.

Personnalisation :

Click pen

11748

A/B SP: max. 4 col.

C/D PD: max. 4 col.

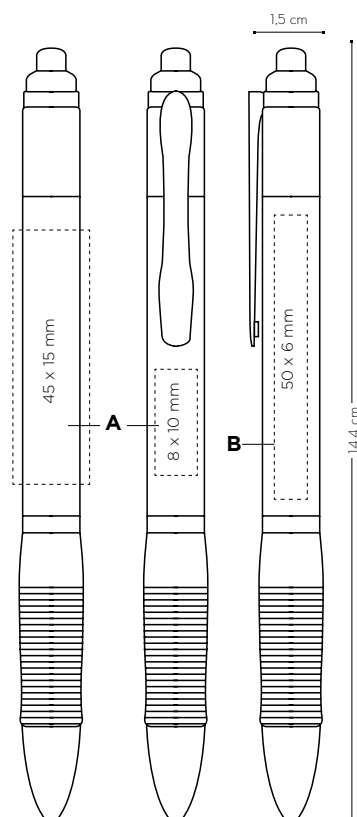

	Prix (€)					
Click pen	500-999	1000-2499	2500-4999	5000-9999	10000-24999	25000-49999
11748						
SP	0,51	0,41	0,35	0,32	①	①
PD	0,58	0,49	0,42	0,39	①	①

COÛTS SUPPLÉMENTAIRES :

SP	0,13	0,13	0,13	0,12	①	①
PD	0,33	0,25	0,18	0,17	①	①

Les prix incluent une impression sur un emplacement avec la technique spécifiée.

① Prix sur demande.

Mode d'écriture :

Bille



M

Techniques d'impression :



(SP) SÉRIGRAPHIE (PD) TAMOGRAPHIE

Emballage externe :



1000 ± 9,5 Kg



Striped Grip pen

11243



AUTRES INSTRUMENTS D'ÉCRITURE

STYLOS PLASTIQUE

Encre de couleur

100%



Commande minimale 500u.

Personnalisation :

Striped Grip pen

11243

A SP: max. 2 col.

B PD: max. 1 col.

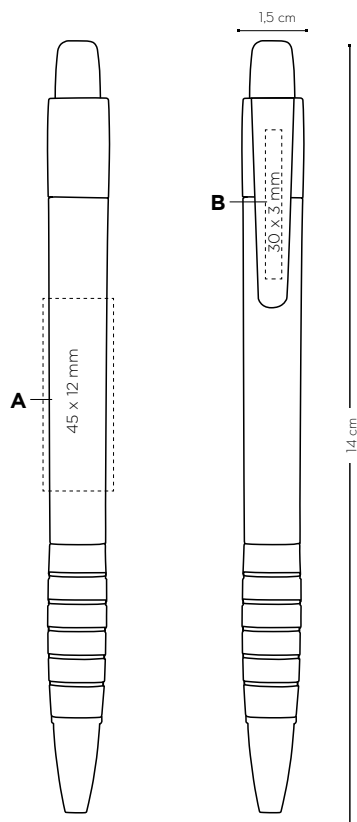

	Prix (€)					
Striped Grip pen	500-999	1000-2499	2500-4999	5000-9999	10000-24999	25000-49999
11243						
SP	0,61	0,51	0,45	0,41	①	①
PD	0,68	0,59	0,52	0,48	①	①

COÛTS SUPPLÉMENTAIRES :

SP	0,13	0,13	0,13	0,12	①	①
PD	0,40	0,32	0,25	0,23	①	①

Les prix incluent la sérigraphie 1 couleur sur un emplacement.

① Prix sur demande.

Mode d'écriture :

Bille



M

Techniques d'impression :



(SP) SÉRIGRAPHIE



(PD) TAMPOGRAPHIE

Emballage externe :



1000 ± 9 Kg



White striped Grip pen

AUTRES INSTRUMENTS D'ÉCRITURE

STYLOS PLASTIQUE



Commande minimale 500v.

Personnalisation :

White striped Grip pen

11303

A SP: max. 2 col.

B PD: max. 1 col.

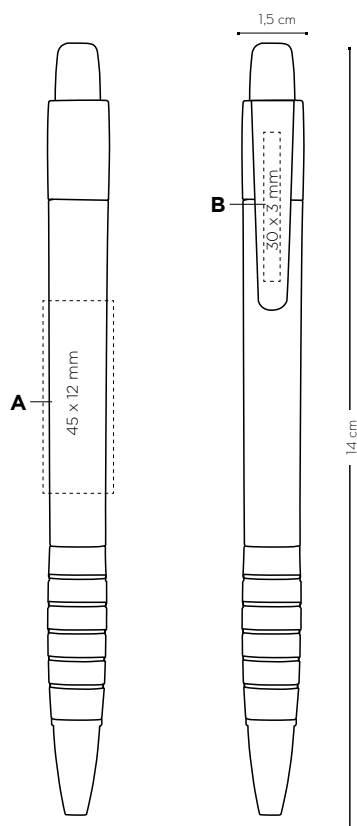

	Prix (€)					
White striped Grip pen	500-999	1000-2499	2500-4999	5000-9999	10000-24999	25000-49999
11303						
SP	0,61	0,51	0,45	0,41	①	①
PD	0,68	0,59	0,52	0,48	①	①

COÛTS SUPPLÉMENTAIRES :

SP	0,13	0,13	0,13	0,12	①	①
PD	0,40	0,32	0,25	0,23	①	①

Les prix incluent la sérigraphie 1 couleur sur un emplacement.

① Prix sur demande.

Mode d'écriture :

Bille



M

Techniques d'impression :



(SP) SÉRIGRAPHIE



(PD) TAMPOGRAPHIE

Emballage externe :



1000 ± 9 Kg



Sleek stylus pen

Sleek stylus pen

11666



Sleek stylus Matt pen

11747



Sleek stylus Executive pen

11976



AUTRES INSTRUMENTS D'ÉCRITURE

STYLOS STYLUS



Commande minimale 100v. (LE)
 Commande minimale 500v. (SP)

Personnalisation :

Sleek stylus pen
 11666

Sleek stylus matt pen
 11747

Sleek stylus executive pen
 11976

A SP: max. 1 col.

B SP: max. 2 col.

C/D/E/F LE

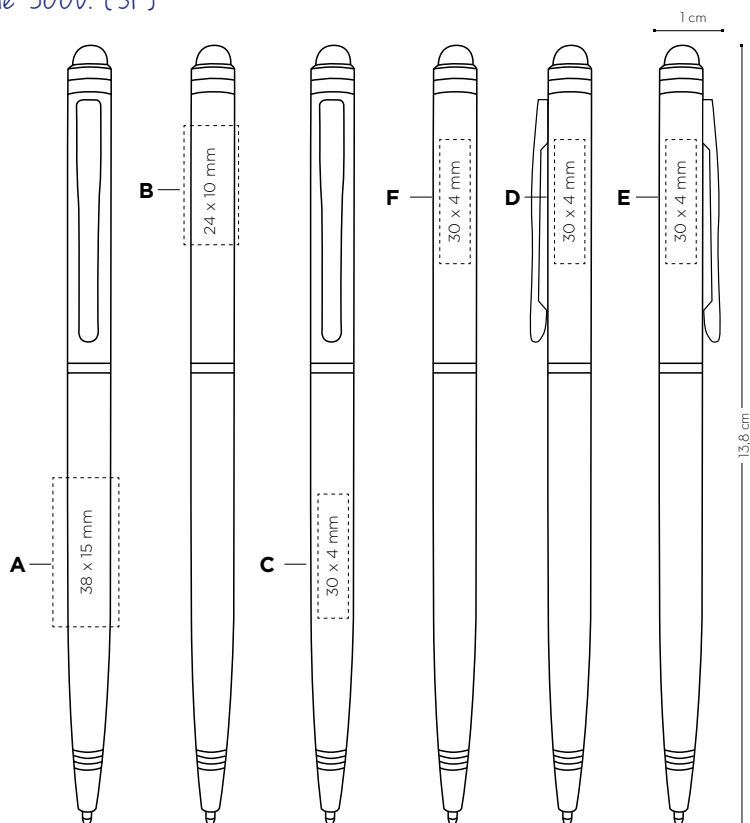

	Prix (€)						
	100-249	300-499	500-999	1000-2499	2500-4999	5000-9999	10000-24999
<i>Sleek stylus pen</i>							
11666							
SP	-	2,19	2,01	1,85	1,79	①	①
LE	3,39	2,87	2,63	2,48	2,45	①	①
11747							
SP	-	2,30	2,11	1,94	1,88	①	①
LE	3,50	2,98	2,73	2,57	2,54	①	①
11976							
SP	-	2,32	2,13	1,96	1,90	①	①
LE	3,52	3,00	2,75	2,59	2,56	①	①

COÛTS SUPPLÉMENTAIRES :

SP	-	0,35	0,30	0,21	0,21	①	①
LE	1,73	1,28	1,10	1,01	0,98	①	①

Les prix incluent la sérigraphie 1 couleur sur un emplacement.

① Prix sur demande.

Mode d'écriture :

Bille



M

Techniques d'impression :



(SP) SÉRIGRAPHIE



(LE) LASER

Emballage externe :



900 ± 12,4 Kg

11666



800 ± 13 Kg

11747

11976

Gravure laser non disponible en couleur jaune / argent

